

**STEIN FILLINGS OF CONTACT STRUCTURES
SUPPORTED BY PLANAR OPEN BOOKS.**

A Thesis
Presented to
The Academic Faculty

by

Amey Kaloti

In Partial Fulfillment
of the Requirements for the Degree
Doctor of Philosophy in the
School of Mathematics

Georgia Institute of Technology
May 2014

Copyright © 2014 by Amey Kaloti

**STEIN FILLINGS OF CONTACT STRUCTURES
SUPPORTED BY PLANAR OPEN BOOKS.**

Approved by:

Professor John Etnyre, Advisor
School of Mathematics
Georgia Institute of Technology

Professor Igor Belgradek
School of Mathematics
Georgia Institute of Technology

Professor Dan Margalit
School of Mathematics
Georgia Institute of Technology

Professor Thang Le
School of Mathematics
Georgia Institute of Technology

Professor Jeremy Van Horn-Morris
Department of Mathematics
University of Arkansas

Date Approved: May 2014

ACKNOWLEDGEMENTS

I would like to thank my advisor John Etnyre for help and encouragement throughout writing of this thesis. In particular, his help in improving the overall exposition and writing of this thesis. I would have never finished this thesis without his help. I would like to thank Dan Margalit for discussions and help regarding the mapping class groups. In particular, I would like to thank Dan for pointing me to relevant papers which form the basis for what is done in this thesis.

I would like to thank my collaborator Youlin Li for letting me use parts of our joint work in this thesis. I would also like to thank Jeremy Van-Horn Morris for help and discussions which were helpful in my understanding of the material involved in this thesis. Thank you to Tom Mark and Laura Starkston for asking me a question during Tech Topology conference in 2013 whose answer led to Theorem 1.0.4. I would also like to thank Patrick Massot for letting me use his pictures of contact structures in this thesis. This research was supported in parts by NSF grant DMS-0804820.

TABLE OF CONTENTS

ACKNOWLEDGEMENTS	iii
LIST OF TABLES	vi
LIST OF FIGURES	vii
SUMMARY	ix
I INTRODUCTION AND STATEMENT OF RESULTS	1
II BACKGROUND	7
2.1 Contact Geometry	7
III CONVEX SURFACES	14
IV KNOTS IN CONTACT MANIFOLDS	19
4.1 Classical invariants of Legendrian knots	20
4.2 Surgeries along Legendrian knots	24
V OPEN BOOK DECOMPOSITIONS	27
VI MAPPING CLASS GROUPS	37
6.0.1 Nielsen-Thurston classification of surface diffeomorphisms	40
VII SYMPLECTIC FILLINGS OF CONTACT MANIFOLDS	44
7.1 Symplectic manifolds and Lefschetz fibrations	44
7.2 Symplectic Fillings	49
7.2.1 Lefschetz fibrations and Stein fillings	60
7.3 Classification of Stein fillings:	63
VIII GEOGRAPHY OF STEIN MANIFOLDS AND CLASSIFICATION FOR LENS SPACES	65
8.1 Characterization of lantern type relations.	65
8.2 Combinatorial arguments	69
8.3 Finiteness of Euler Characteristics and Signature	79
8.4 Euler characteristic of sphere plumbings	84

IX STEIN FILLINGS OF MANIFOLDS OBTAINED BY LEGEN-	
DRIAN SURGERIES ALONG KNOTS	88
9.1 Classification of Stein fillings	88
9.1.1 The positive factorizations.	91
9.1.2 Stein fillings of certain planar open books	97
9.1.3 Proofs of the theorems	100
9.1.4 Uniqueness of certain Stein fillings up to symplectic	
deformation equivalence	101
INDEX	112

LIST OF TABLES

LIST OF FIGURES

1	A Legendrian link one of whose components is a Legendrian twist knot K_{-2p} , where the box consists of $2p - 2$ Legendrian tangle. There are $k - 1$ upward cusps of the Legendrian K_{-2p} each of which hooks $m_i - 1$ Legendrian unknots for $i = 1, \dots, k - 1$. There are $n - k$ downward cusps of the Legendrian K_{-2p} each of which hooks $m_i - 1$ Legendrian unknots for $i = k + 1, \dots, n$	5
2	A 2-bridge knot $B(p, q)$ with $p, q > 0$. The boxes containing $-2p$ and $-2q$ denote $2p$ and $2q$ negative half twists, respectively.	6
3	The contact structure ξ_{std} on \mathbb{R}^3 . Picture by Patrick Massot.	8
4	The contact structure ξ_{ot} on \mathbb{R}^3 . Picture by Patrick Massot.	9
5	The front projection of a Legendrian unknot on the left and the front projection of a Legendrian right handed trefoil on the right.	20
6	The sign convention used in computing linking numbers in \mathbb{R}^3 . A positive crossing is shown on the left and a negative crossing is shown on the right.	22
7	Stabilizing a Legendrian knot in $(\mathbb{R}^3, \xi_{std})$. In the middle we show a strand of a Legendrian knot, the right picture shows adding a down cusp and the left picture shows adding up cusp.	23
8	Stabilizing a Legendrian knot on the page of an open book decomposition. In the middle we show a Legendrian knot sitting on a page of open book decomposition, the right picture shows a positive stabilization of the knot and the left picture shows a negative stabilization of the knot.	35
9	Classical Lantern relation.	66
10	Figure shows the configuration of curves used in Lemma 8.2.7. The arcs a_i and b_i can be cut along to get a disk with 3 boundary components in the proof of Theorem 8.2.9.	74
11	Surgery diagram for lens spaces $L(p(m + 1) + 1, m + 1)$. In the diagram \mathcal{K} is the maximal tb unknot stabilized positively r times and negatively $p - r - 1$ times. As we vary r from 0 to $p - 1$ we get all the contact structures on these lens spaces.	78
12	Open book for (S^3, ξ_{std}) on left and open book supporting the lens space $L(p(m + 1) + 1, (m + 1))$ is shown.	80
13	A compact planar surface Σ with $n + q + p + 1$ boundary components.	89

14	Arc γ along which the surface is cut open is shown in the left picture. The right picture shows the cut open surface.	92
15	Another choice of the arc for the curve B_2'' shown in the left. The right one is obtained from the left one by a diffeomorphism moving the hole c_1 to the right and the hole c_2 to the left.	94
16	Arc γ along which the surface is cut open is shown in the left picture. The right picture shows the cut open surface.	95
17	Arcs γ_1 and γ_2 along which the surface is cut open is shown in the left picture. The right picture shows the cut open surface, where γ_i^1 and γ_i^2 are two copies of γ_i , for $i = 1, 2$	95
18	The left two figures indicate the two choices of the curve B_2'' . The upper left figure is $(\Sigma, \tau_1\tau_2\tau_3\tau_5\tau_{B_1}\tau_{B_2''})$. The lower left figure is $(\Sigma, \tau_1\tau_2\tau_3\tau_5\tau_{B_1}\tau_{B_2''})$ which is conjugate to $(\Sigma, \tau_1\tau_2\tau_3\tau_5\tau_{B_2''}\tau_{B_1})$. The right two figures are their corresponding Kirby diagrams for the Stein filling, where each dotted circle is a 4-dimensional 1-handle, and all other circles have surgery coefficients -1 . These two Kirby diagrams denote two diffeomorphic 4-manifolds.	98
19	An embedded open book decomposition supporting (S^3, ξ_{std}) with a twist knot K_{-2p} and some unknots on a page.	100

SUMMARY

In this thesis we study topology of symplectic fillings of contact manifolds supported by planar open books. We obtain results regarding geography of the symplectic fillings of these contact manifolds. Specifically, we prove that if a contact manifold (M, ξ) is supported by a planar open book, then Euler characteristic and signature of any Stein filling of (M, ξ) is bounded. We also prove a similar finiteness result for contact manifolds supported by spinal open books with planar pages. Moving beyond the geography of Stein fillings, we classify fillings of some lens spaces.

In addition, we classify Stein fillings of an infinite family of contact 3-manifolds up to diffeomorphism. Some contact 3-manifolds in this family can be obtained by Legendrian surgeries on (S^3, ξ_{std}) along certain Legendrian 2-bridge knots. We also classify Stein fillings, up to symplectic deformation, of an infinite family of contact 3-manifolds which can be obtained by Legendrian surgeries on (S^3, ξ_{std}) along certain Legendrian twist knots. As a corollary, we obtain a classification of Stein fillings of an infinite family of contact hyperbolic 3-manifolds up to symplectic deformation.

CHAPTER I

INTRODUCTION AND STATEMENT OF RESULTS

The objects of study in this thesis are contact manifolds in dimension 3 and their symplectic fillings. Given a smooth, closed, oriented 3 manifold M , a co-orientable contact structure on M is a maximally non integrable plane field ξ . It is a classical result due to Thom that any closed 3-manifold M is a boundary of a smooth 4-manifold X . A natural question to ask then is: can any contact 3-manifold (M, ξ) be obtained as boundary of some 4-manifold X ? This question as stated is not meaningful. First we need to put some restrictions on X . The first natural condition here is that X be symplectic. A closed 2-form ω (i.e. $d\omega = 0$) on a 4-manifold is called symplectic if $\omega \wedge \omega > 0$. We will denote the symplectic manifold by (X, ω) . Even with this restriction one needs certain compatibility condition between the symplectic structure on X and the contact structure on M . To see a compatibility condition we recall a few more notions. A Liouville vector field on (X, ω) is a vector field such that $\mathcal{L}_v \omega = \omega$, where \mathcal{L} denotes the Lie derivative. A symplectic manifold (X, ω) is called a strong symplectic filling of a contact manifold (M, ξ) if ∂X is diffeomorphic to M , there exists a Liouville vector field v in the neighbourhood of ∂X such that v is transverse pointing out of ∂X and the contact structure ξ is given by $i^*(i_v(\omega))$.

There is a “strictly ”stronger notion of fillability called Stein fillability which we recall now. A Stein domain X is a complex manifold (X, J) such that there is a biholomorphic embedding of (X, J) in \mathbb{C}^N for some $N \in \mathbb{N}$. Here J denotes the almost complex structure associated to the complex structure on X . An almost complex structure on a 4 manifold X is an endomorphism $J : TX \rightarrow TX$ such that $J^2 = -Id$. A Stein domain (X, J) is said to be a filling of (M, ξ) if ∂X is diffeomorphic

to M and ξ is given by complex tangencies i.e. $\xi = J(TM) \cap TM$. For other notions of symplectic fillings and more on Stein fillings we refer the reader to Chapter 7.

Now we can ask the fillability question again. Given a contact manifold (M, ξ) , is it fillable (Stein or symplectic)? If (M, ξ) is fillable, how many “different” fillings does it have? Can we say anything about the algebraic topology of the fillings of (M, ξ) ? In this thesis we will study these and related questions.

For notions of open book decompositions and their relations to contact structures we refer the reader to Chapter 5. For notion of Legendrian surgery we refer the reader to Chapter 4.

In all the theorems stated below we talk about planar open book. Here planar refers to a planar surface i.e. a sphere with a finite number of open disks removed from the interior. We denote the sphere with $n + 1$ disks removed by \mathbb{D}_n .

We start by trying to understand the algebraic topology of Stein fillings. If we denote the Euler characteristic and signature of X by $\chi(X)$ and $\sigma(X)$, respectively, then the geography problem is to determine the following set

$$\mathcal{C}_{(M, \xi)} = \{(\sigma(X), \chi(X)) \mid X \text{ is a Stein filling of } (M, \xi)\}.$$

In particular, it is interesting to know whether this set is finite. It has been a conjecture of Stipsicz [69], that $\mathcal{C}_{(M, \xi)}$ is finite for any (M, ξ) . Although, the conjecture in full generality has been recently proven to be false by Baykur and Van Horn-Morris [5], we prove it is true for contact structures supported by planar open books.

Theorem 1.0.1. *Let (M, ξ) be a tight contact manifold supported by planar open book. Then the set $\mathcal{C}_{(M, \xi)}$ is finite. In particular, there exists a positive integer N such that signature and Euler characteristic of X satisfy, $|\sigma(X)| < N$ and $|\chi(X)| < N$ for any Stein filling (X, J) of (M, ξ) .*

Remark 1.0.2. *After the paper was submitted, Jeremy Van Horn-Morris pointed out to the author that Plamenevskaya had proved finiteness of Euler characteristic in her*

paper [65]. The author was unaware of this result.

A generalization of the notion of open books is spinal open book [53]. We have a corresponding theorem as above in the case of contact manifolds supported by spinal open books with planar pages.

Theorem 1.0.3. *Let (M, ξ) be a contact structure supported by spinal open book with connected planar pages. Then $\mathcal{C}_{(M, \xi)}$ is finite. In particular, there exists a positive integer N such that for any Stein filling (X, J) of (M, ξ) , $|\chi(X)| < N$ and $|\sigma(X)| < N$.*

In addition, we use the methods developed in this thesis to get an explicit upper bound on the Euler characteristic of a particular contact structure. Let $C = C_1 \cup C_2 \cup \dots \cup C_n$ denote a configuration of symplectic spheres in a symplectic manifold (X, ω) intersecting ω -orthogonally according to a connected plumbing graph Γ with negative definite intersection form $Q = (q_{ij}) = [C_i] \cdot [C_j]$. We assume that there are no edges connecting a vertex to itself. Suppose that for each row in Q , we have a non positive sum $\sum_j q_{ij} \leq 0$. It follows from a result of Gay and Mark [29], that any neighbourhood of such a configuration of symplectic spheres C contains a neighbourhood (Z, η) of C with strong convex boundary. The boundary M of (Z, η) has a natural contact structure which we denote by ξ_{pl} .

Theorem 1.0.4. *Let (M, ξ_{pl}) be contactomorphic to the boundary of (Z, η) which is a plumbing of spheres as defined above. If (X, J) is a strong symplectic filling of (M, ξ_{pl}) , then $\chi(X) \leq \chi(Z)$.*

This theorem answers a special case of a question raised by Starkston. See Question 6.2 in [67].

Moving beyond the geography of symplectic fillings, we study classification problem. More precisely, given a contact 3-manifold (M, ξ) we would like to know set of all

possible symplectic fillings (X, ω) up to a diffeomorphism of X or symplectomorphism of (X, ω) .

This in general is a very hard problem. Only partial progress has been made in some very special cases. In this thesis we prove classification results some up to diffeomorphism and some up to symplectomorphism. In this regard we have the following:

Theorem 1.0.5. *Let ξ be a contact structure on lens space $L(p(m+1)+1, (m+1))$.*

If ξ is:

1. *Virtually overtwisted, then ξ has a unique Stein filling upto symplectomorphism.*
2. *Universally tight and $p \neq 4, 5, \dots, (m+4)$, then ξ has a unique Stein filling upto symplectomorphism.*
3. *Universally tight and $p = 4, 5, \dots, (m+4)$, then ξ has at least two Stein fillings upto symplectomorphism.*

In a joint work with Youlin Li [44], we have proved some more classification results. We state these theorems below. All the theorems stated below are based on our joint work.

In (S^3, ξ_{std}) , let L be a Legendrian twist knot, K_{-2p} , with Thurston-Bennequin invariant -1 and rotation number 0 , where $2p$ denotes the number of left-handed half twists. If $p = 1$, then it is a right handed trefoil. See Figure 1 for one of its front projections. According to [18], such a Legendrian twist knot L is unique up to Legendrian isotopy. Let $n, k \geq 1$ be two integers such that $n \geq k$. Let $S_+^{n-k} S_-^{k-1}(L)$ be the result of $n-k$ positive stabilizations and $k-1$ negative stabilizations of L . Figure 1 depicts a Legendrian link in (S^3, ξ_{std}) one of whose components is $S_+^{n-k} S_-^{k-1}(L)$. The other components are all Legendrian unknots with Thurston-Bennequin invariant -1 , pushed off m_i times, where m_i is a non-negative integer for $i = 1, \dots, k-1, k+1, \dots, n$

if $k > 1$ or $n > k$. Let (M', ξ') denote a contact structure obtained by performing Legendrian surgery along all the components of the link given in Figure 1. Then we prove the following theorem.

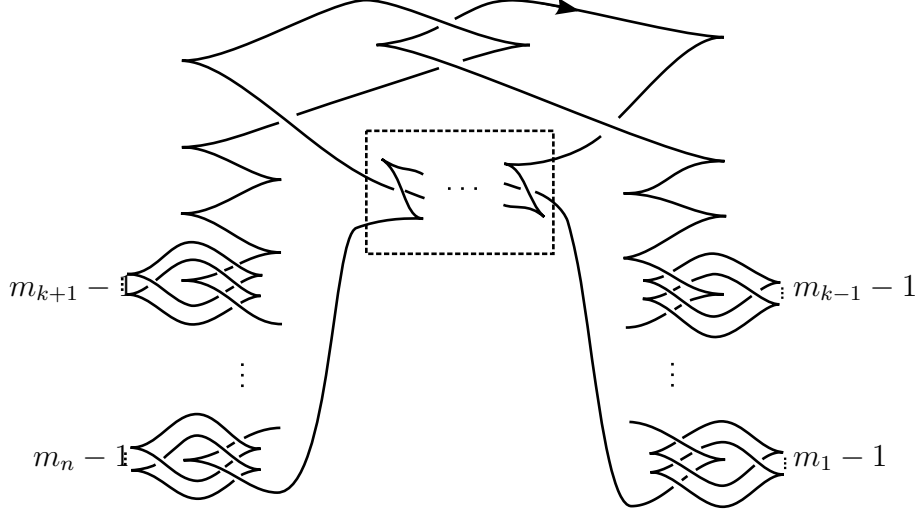

Figure 1: A Legendrian link one of whose components is a Legendrian twist knot K_{-2p} , where the box consists of $2p - 2$ Legendrian tangle. There are $k - 1$ upward cusps of the Legendrian K_{-2p} each of which hooks $m_i - 1$ Legendrian unknots for $i = 1, \dots, k - 1$. There are $n - k$ downward cusps of the Legendrian K_{-2p} each of which hooks $m_i - 1$ Legendrian unknots for $i = k + 1, \dots, n$.

Theorem 1.0.6. *The contact 3-manifold (M', ξ') has a unique Stein filling up to diffeomorphism.*

This theorem follows from a more general theorem (see Theorem 9.0.3) we will state and prove in Chapter 9. Another application of the Theorem 9.0.3 is classifying Stein fillings of manifolds obtained by Legendrian surgeries along some Legendrian 2-bridge knots. Figure 2 depicts a 2-bridge knot $B(p, q)$, where p, q are positive intergers. If $q = 1$, then it is the twist knot K_{-2p} .

Theorem 1.0.7. *There is a Legendrian 2-bridge knot $B(p, q)$ with Thurston-Bennequin invariant -1 and rotation number 0 , such that the Legendrian surgery on (S^3, ξ_{std}) along any of its stabilization yields a contact 3-manifold with unique Stein filling up to diffeomorphism.*

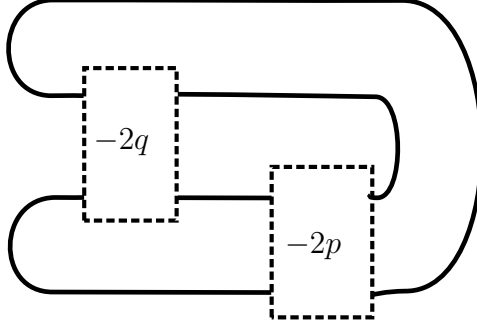

Figure 2: A 2-bridge knot $B(p, q)$ with $p, q > 0$. The boxes containing $-2p$ and $-2q$ denote $2p$ and $2q$ negative half twists, respectively.

In addition to classifying Stein fillings up to diffeomorphism, we can classify Stein fillings of Legendrian surgeries along some Legendrian twist knots up to symplectic deformation. Even though these manifolds admit open books considered in Theorem 9.0.3, we include a separate proof here because the notion of symplectic deformation is stronger than that of diffeomorphism.

Theorem 1.0.8. *If L is a Legendrian twist knot K_{-2p} with Thurston-Bennequin invariant -1 and rotation number 0 , then the Legendrian surgery on (S^3, ξ_{std}) along any stabilization of L yields a contact 3-manifold with unique Stein filling up to symplectic deformation equivalence.*

If $p > 1$, then the twist knot K_{-2p} is hyperbolic. By the hyperbolic Dehn surgery theorem in [71], Legendrian surgery on (S^3, ξ_{std}) along a Legendrian hyperbolic twist knot with sufficiently many stabilizations yields a contact hyperbolic 3-manifold. So, immediately, we have

Theorem 1.0.9. *There are infinitely many contact hyperbolic 3-manifolds admitting unique Stein filling up to symplectic deformation equivalence.*

One important aspect of these classification is that the techniques developed for classifying. In general, we can classify more symplectic fillings and the technique developed here serve as tools that can be used in future for other classification.

CHAPTER II

BACKGROUND

In this chapter we give background on basics of contact geometry. Contact geometry has its origins in physics and geometric optics. In last few years the field has grown with the advent of new techniques. In this background chapter we try to give a flavour for various notions involved.

2.1 Contact Geometry

Let us fix a smooth odd dimensional manifold M^{2n+1} . Let ξ denote a smooth codimension 1 sub-bundle of the tangent bundle TM . Sometimes this is called hyperplane distribution.

Lemma 2.1.1. *Let M be an orientable manifold. Then Locally ξ can be written as the kernel of a differential 1-form α . Moreover, it is possible to write $\xi = \ker(\alpha)$ globally if and only if ξ is co-orientable.*

Proof. Fix a metric g on M . The orthogonal complement ξ^\perp satisfies $TM = \xi \oplus \xi^\perp$. Around any point p , there is a neighbourhood U such that the line bundle ξ^\perp is trivial. Let X be a non-zero section of ξ^\perp in U and define $\alpha = g(X, -)$ in U . Then clearly $\xi|_U = \ker(\alpha)$.

Now we prove the second part of the lemma. Saying that ξ is co-orientable is equivalent to ξ^\perp being trivial. In that case X as constructed above exists globally and hence the 1-form α is also defined globally. Conversely, if $\xi = \ker(\alpha)$ is defined globally then one can find a globally defined section of ξ^\perp such that $g(X, X) = 1$ and $\alpha(X) > 0$. This gives the required co-orientation for ξ^\perp .

□

For rest of this thesis we will assume that our hyperplane fields are co-oriented. We define contact structures which are objects of study in this thesis.

Definition 2.1.2. A co-orientable contact structure $\xi = \ker(\alpha)$ on M^{2n+1} is a totally non-integrable hyperplane distribution, in other words $\alpha \wedge (d\alpha)^n \neq 0$.

A positive contact structure on an oriented manifold M is a hyperplane distribution such that $\alpha \wedge (d\alpha)^n$ defines a volume form defining the given orientation on M . We will always talk about positive contact structures in this thesis. Before moving forward we give a couple of illustrative examples of contact structures.

Example 2.1.3. Let $M = \mathbb{R}^3$ with coordinates (x, y, z) define a 1 form $\alpha = dz - ydx$. One can check that $\alpha \wedge d\alpha = dx \wedge dy \wedge dz$. So $\xi_{std} = \ker(\alpha)$ defines a contact structure on \mathbb{R}^3 . One can draw this contact structure as below.

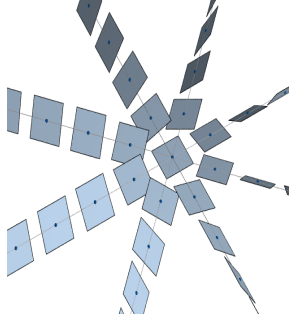

Figure 3: The contact structure ξ_{std} on \mathbb{R}^3 . Picture by Patrick Massot.

Example 2.1.4. On $M = \mathbb{R}^3$ with cylindrical coordinates (r, θ, z) define a contact structure as $\xi_{ot} = \ker(\cos(r)dz + r\sin(r)d\theta)$. As above it is easy to check that this defines a contact structure. We draw this contact structure below.

Example 2.1.5. Let $M = S^3$. Think of S^3 as a unit sphere in \mathbb{R}^4 with coordinates (x_1, y_1, x_2, y_2) . Define a plane distribution by $\xi_{std} = \ker(x_1dy_1 - y_1dx_1 + x_2dy_2 - y_2dx_2)$. Again it is easy to check that this defines a contact structure.

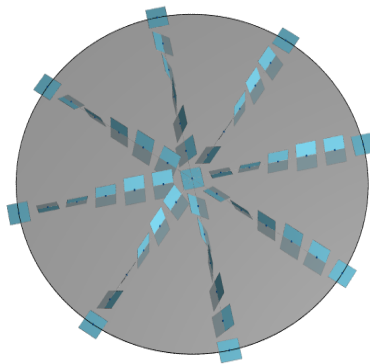

Figure 4: The contact structure ξ_{ot} on \mathbb{R}^3 . Picture by Patrick Massot.

Now it is not clear if the two contact structures given in the first two examples above are “equivalent ” or if they are different. To make this notion of equivalence precise we define:

Definition 2.1.6. *Let ξ_1 and ξ_2 be two contact structures on a manifold M . We say ξ_1 is **contactomorphic** to ξ_2 if there exists a diffeomorphism ϕ of M such that $\phi_*\xi_1 = \xi_2$.*

One can prove that $(S^3 - \{pt\}, \xi_{std}|_{S^3-pt})$ considered in Example 2.1.5 is contactomorphic to (\mathbb{R}^3, ξ_{st}) considered in Example 2.1.3. It follows from work of Bennequin [6] that on \mathbb{R}^3 the contact structures ξ_{std} and ξ_{ot} are not contactomorphic. A reason for this is that in ξ_{ot} one can see an embedded disk given by $D = \{r = \pi, z = 0\}$. One can easily check that the contact planes along the ∂D do not twist at all. It is obvious as the contact planes along ∂D are given by $span\{\partial_x, \partial_y\}$. Such a disk can not exist in ξ_{std} . Existence of such a disk is a fundamental phenomenon in 3 dimensional contact geometry due to foundational work of Eliashberg [10].

Definition 2.1.7. *A contact 3-manifold (M, ξ) is **overtwisted** if it contains an embedded disk D , called the **overtwisted disk**, such that $\xi|_{\partial D} = TD|_{\partial D}$ and the characteristic foliation of D contains a unique singular point at the origin. If (M, ξ) does not contain*

an overtwisted disk then it is called tight.

We will come back to this point later. But we first prove Gray's stability theorem, which is very widely used in contact topology.

Theorem 2.1.8 (Gray stability theorem). *Let ξ_t , for $t \in [0, 1]$, be a smooth family of contact structures on a closed manifold M . Then there is an isotopy $(\psi_t)_{t \in [0, 1]}$ of M such that $(\psi_t)_*(\xi_t) = \xi_0$.*

Proof. The idea is to assume that ψ_t is a flow of some time dependent vector field v_t . Then the desired isotopy equation translates in an equation for v_t . If this can be solved, then we can find the isotopy by integrating v_t . This is the idea of Moser's technique. Towards that end, let $\xi_t = \ker(\alpha_t)$ for a smooth family of 1-forms α_t . Then we want to find a family of diffeomorphisms $\psi_t : M \rightarrow M$ and a family of functions $\lambda_t : M \rightarrow \mathbb{R}^+$ such that

$$\psi_t^* \alpha_t = \lambda_t \alpha_0. \quad (1)$$

Differentiating the left hand side with respect to t yields,

$$\begin{aligned} \frac{d}{dt}(\psi_t^* \alpha_t) &= \lim_{h \rightarrow 0} \frac{\psi_{t+h}^* \alpha_{t+h} - \psi_t^* \alpha_t}{h} \\ &= \lim_{h \rightarrow 0} \frac{\psi_{t+h}^* \alpha_{t+h} - \psi_{t+h}^* \alpha_t + \psi_{t+h}^* \alpha_t - \psi_t^* \alpha_t}{h} \\ &= \lim_{h \rightarrow 0} \psi_{t+h}^* \frac{\alpha_{t+h} - \alpha_t}{h} + \lim_{h \rightarrow 0} \frac{\psi_{t+h}^* \alpha_t - \psi_t^* \alpha_t}{h} \\ &= \psi_t^* (\dot{\alpha}_t + \mathcal{L}_{v_t} \alpha_t). \end{aligned}$$

Now differentiating Equation 1 we get,

$$\psi_t^* (\dot{\alpha}_t + \mathcal{L}_{v_t} \alpha_t) = \dot{\lambda}_t \alpha_0 = \frac{\dot{\lambda}_t}{\lambda_t} \psi_t^* \alpha_t.$$

By Cartan's formula $\mathcal{L} = d \circ i_x + i_x \circ d$ we get

$$\psi_t^* (\dot{\alpha}_t + d(\alpha_t(v_t)) + i_{v_t} d\alpha_t) = \psi_t^* (\nu_t \alpha_t).$$

where $\nu_t := \frac{d}{dt}(\log \lambda_t) \circ \psi_t^{-1}$.

Let $v_t \in \xi_t$. Then $d(\alpha_t(v_t)) = 0$. Now multiplying by $(\psi_t^{-1})^*$ and then plugging the Reeb vector field (i.e. the unique vector field R_t satisfying $\alpha_t(R_t) = 1, i_{R_t}d\alpha_t = 0$) in the equation gives,

$$\dot{\alpha}_t(R_t) = \nu_t$$

This determines $v_t \in \xi_t$ uniquely by non-degeneracy of $d\alpha_t|_{\xi_t}$.

□

We now prove an important theorem which shows that locally all contact manifolds look the same. The proof of this result is similar to the proof above using Moser's technique. We will skip it here.

Theorem 2.1.9 (Darboux). *Every contact $2n + 1$ manifold (M, ξ) locally looks like $(\mathbb{R}^{2n+1}, \xi_{st})$, i.e., for all $p \in M$ there exists an open neighbourhood U of p in M and V of 0 in \mathbb{R}^{2n+1} and a contactomorphism $\phi : (U, \xi) \rightarrow (V, \xi_{st})$, such that $\phi(p) = 0$. Here $\xi_{st} = \ker(dz - \sum y_i dx_i)$ is the standard contact structure on \mathbb{R}^{2n+1} , where we choose co-ordinates $(x_1, y_1, x_2, y_2, \dots, x_n, y_n, z)$.*

This theorem implies that there are no local invariants of contact manifolds. In our study of contact manifolds and their fillings we will not be particularly concerned with this aspect.

We now return to the notion of overtwistedness. The tight vs. Overtwisted dichotomy has been influential in driving contact geometry research. This dichotomy exists because the existence of overtwisted disk guarantees flexibility as is evident from the following theorem of Eliashberg.

Theorem 2.1.10. *Let $\Xi^{ot}(M, \delta)$ denote the space of co-oriented, positive contact structures on M that contain a standard overtwisted δ and let $Dist(M, \delta)$ denote the*

space of co-oriented plane distributions on M that are tangent to δ at the center of δ . Then the inclusion map

$$i_\delta : \Xi^{ot}(M, \delta) \rightarrow \text{Dist}(M, \delta)$$

is a weak homotopy equivalence.

Recall that a weak homotopy equivalence between two topological spaces X, X' is a continuous map from X to X' , that induces a bijection between the path components of the spaces X, X' and isomorphism $\pi_k(X) \rightarrow \pi_k(X'), k \in \mathbb{N}$ on all homotopy groups.

This in effect says that the isotopy classification of overtwisted manifolds is same as homotopy classification of the underlying plane fields. So overtwisted manifolds in some sense are easy to understand and in particular any 3 manifold admits infinitely many overtwisted contact structures.

Tight contact structures on the other hand are hard to understand, but they interact nicely with the underlying topology of the 3 manifold. So a first natural question is whether any closed 3 manifold admits a tight contact structure? The answer is no as shown by following theorem of Etnyre and Honda [24].

Theorem 2.1.11 (Etnyre-Honda). *The Poincare homology 3 sphere $\overline{\Sigma(2, 3, 5)}$ with reversed orientation does not carry a tight contact structure.*

More example were given by Lisca and Stipsicz [51]. These examples are obtained as surgeries along torus knots in S^3 . So now a natural question is to ask which closed 3 manifolds admit tight contact structures. This question is still not answered. In particular, it is not known whether every hyperbolic 3 manifold admits tight contact structure. But the existence question was completely resolved for Seifert fibered 3 manifolds by Lisca and Stipsicz [52]

Theorem 2.1.12 (Lisca-Stipsicz). *Let M_n denote the closed 3 manifold obtained by $2n - 1$ surgery along torus knot $T_{2,2n+1}$ in S^3 . A closed oriented Seifert fibered*

3 manifold Y either carries a tight contact structure or is orientation preserving diffeomorphic to M_n for some $n \geq 1$.

Another important question is of the classification of tight contact structures on a fixed 3 manifold M up to contactomorphism or isotopy. Eliashberg proved that S^3 carries a unique tight contact structure ξ_{std} . Other classification results are known on lens spaces $L(p, q)$ due to Honda [42] and Giroux [35], on some Seifert fibered spaces [80, 33, 34].

A couple of related notions we will need in this thesis are virtually overtwisted and universally tight.

Definition 2.1.13. *A contact structure ξ on M is called universally tight if the pull back of ξ to the universal cover of M is tight. It is called virtually overtwisted if pullback of ξ to some finite cover is overtwisted.*

With this preliminary introduction to contact geometry we move onto basics of convex surface theory which will be lurking in the background for a lot of results used in this thesis.

CHAPTER III

CONVEX SURFACES

Let (M, ξ) be a contact 3 manifold and let S be an oriented embedded surfaces. Since a contact distribution is a 2 plane distribution, $\xi_p \cap T_p S$ is a line field except for the points at which ξ_p and $T_p S$ are identical. So we get an induced foliation on the surface S with some singularities i.e. points where $\xi_p = T_p S$.

Definition 3.0.14 (Characteristic Foliations). *The characteristic foliation S_ξ of a surface S in (M, ξ) is the singular 1-dimensional foliation of S defined by the distribution $(TS \cap \xi|_S)^\perp$. Here \perp denotes the symplectic complement with respect to the symplectic structure $d\alpha$ on ξ . At points $p \in S$ where $T_p S \cap \xi_p$ is 1 dimensional $(T_p S \cap \xi_p)^\perp = T_p S \cap \xi_p$.*

It is a standard fact (see [31] Lemma 2.5.20) that S_ξ can also be given by a vector field X in TS , such that $i_X \Omega = \alpha|_S$ where Ω is volume form on S . It is also not very hard to see that the equivalence class of X depends only on S and ξ . Two vector fields X and X' on the surface S are called equivalent if there is a smooth function $f : S \mapsto \mathbb{R}^+$ such that $X' = fX$. Note that at point $p \in S$, $\alpha_p(X_p) = \Omega(X_p, X_p) = 0$. Hence, $X_p \in \xi_p$ and $X_p = 0$ if and only if $\xi_p = T_p S$. The second statement follows easily from the fact that Ω is a volume form on S and hence is non-degenerate. The following lemma gives a characterization of the vector fields X defining a characteristic foliation on the surface S .

Lemma 3.0.15. *A vector field X on S defines a characteristic foliation S_ξ for some contact structure ξ on $S \times (-\epsilon, \epsilon)$ if and only if $X_p = 0$ implies $\text{div}_\Omega(X) \neq 0$ at p .*

Now suppose that S_0 and S_1 are two surfaces in a contact manifold (M, ξ) such that there is a diffeomorphism $\phi : S_0 \rightarrow S_1$ taking characteristic foliation of S_0 to

the characteristic foliation of S_1 . Giroux proved that one can then extend ϕ to a contactomorphism of a neighbourhood $N(S_0)$ of S_0 to a neighbourhood $N(S_1)$ of S_1 . For the proof of this fact we refer the reader to Geiges's book [31].

Given a generic singular foliation induced by a vector field X we now proceed to study the singularities of the vector field and see how they are useful. A generic such vector field X will have isolated singularities. So in a local neighbourhood around the singular point p we can assume that $p = (0, 0)$ in \mathbb{R}^2 with area form $dx \wedge dy$. If $X = f \frac{\partial}{\partial x} + g \frac{\partial}{\partial y}$ then the foliation is given by the flow lines $\dot{\gamma} = X_{\gamma(t)}$. The linearisation is given by

$$A = \begin{bmatrix} f_x & f_y \\ g_x & g_y \end{bmatrix}.$$

In this local co-ordinate chart divergence is given by $f_x + g_y$. We define a singular point to be *elliptic* if $\det(A) > 0$ and *hyperbolic* if $\det(A) < 0$. In the case that the foliation is induced by a contact structure we can additionally define sign of each critical point. In this case we define sign of p to be the sign of $\text{div}_X \Omega$. It follows from the discussion above that the sign of p is $+1$ if and only if $T_p S$ and ξ_p have the same orientation. If p is elliptic then the sign of p is $+1$ for a source and -1 for a sink. If p is hyperbolic then the sign of the hyperbolic point is given by the sign of the eigenvalue of A which has bigger magnitude.

Definition 3.0.16 (Morse-Smale foliation). *A foliation is Morse-Smale if the singularities and the closed orbits are nondegenerate, α - and ω - limit set of each flow line (i.e. the set of limit points γ_{t_i} with $t_i \rightarrow -\infty$ or $\rightarrow \infty$) is either a singular point or a closed orbit, and there are no flow lines connecting pairs of hyperbolic singularities.*

We will see that the Morse-Smale foliations are important in the study of convex surface theory.

Theorem 3.0.17. *Given a closed, orientable surface $S \subset (M, \xi)$, there is a C^∞ -small perturbation S' of S , so that S'_ξ is Morse-Smale.*

We are ready for the definition of convex surface.

Definition 3.0.18. *A contact vector field v is a vector field on M whose flow preserves ξ . A surface $S \subset (M, \xi)$ is called convex if there is a contact vector field transverse to S .*

Note that if we write $\xi = \ker(\alpha)$, then the fact that the flow ϕ_t of v preserves the contact structure implies $\phi_t^*\alpha = f_t\alpha$ for some f_t . Now it follows that v is contact if and only if $\mathcal{L}_v\alpha = g\alpha$ for some g . An example of a contact vector field is Reeb vector field. We now tie this to the Morse-Smale foliations defined above.

Theorem 3.0.19. *If a surface $S \subset (M, \xi)$ has a Morse-Smale characteristic foliation then S is convex.*

We still have not seen why convex surfaces are important. The point of convex surface theory developed by Giroux is that to describe the contact structure in a neighbourhood of a surface one needs very little information. Specifically one only needs to know some curves on the surface and not the whole characteristic foliation. First we try to characterize neighbourhoods of convex surfaces.

Theorem 3.0.20. *A surface $S \subset (M, \xi)$ is convex if and only if there is an embedding $\phi : S \times \mathbb{R} \hookrightarrow M$ with $S = \phi(S \times \{0\})$, such that $\phi^*(\xi)$ is invariant in the \mathbb{R} direction.*

Another important piece of information about convex surface is carried by dividing set.

Definition 3.0.21 (Dividing Set). *Let S be a surface with singular foliation \mathcal{F} . A multi-curve $\Gamma \subset S$ that is transverse to \mathcal{F} is said to divide S if S admits a volume form ω and a vector field v directing \mathcal{F} such that $S \setminus \Gamma = S_+ \cup S_-$ with $\pm \mathcal{L}_v\omega > 0$ on S_{\pm} and v points out of S_+ along Γ .*

If S is convex, then in a vertically invariant neighbourhood (guaranteed by the above theorem), the contact form can be written as $\alpha = \beta + fdt$ for some smooth

function $f : S \rightarrow \mathbb{R}$ and 1-form β on S . The contact condition can be expressed now as

$$fd\beta - df \wedge \beta > 0$$

on S . Now take as the volume form $\Omega = fd\beta - df \wedge \beta$ and X to be the vector field such that $i_X\Omega = \beta$. Such a vector field exists because of nondegeneracy of Ω . This vector field directs the characteristic foliation S_ξ . So

$$S_\pm = \{p \in S \mid \pm f(p) > 0\}.$$

Thus the curves given by

$$\Gamma_S = f^{-1}(0)$$

are easily checked to divide S_ξ and are called the dividing curves.

So using the model neighbourhood $S \times \mathbb{R}$ as above and the contact vector field $\frac{\partial}{\partial t}$, we have that $v_p \in \xi_p$ if and only if $f = 0$. This gives another way of characterizing the dividing set as

$$\Gamma_S = \{p \in S \mid v_p \in \xi_p\}.$$

As said before it is the dividing set that carries information about the contact structure in a neighbourhood of convex surface. This is captured in the following theorems.

Theorem 3.0.22. *Let $S \subset (M, \xi)$ be an orientable surface with Legendrian boundary. Then S is convex if and only if the characteristic foliation S_ξ admits dividing curves.*

We already have proved the forward direction. We will skip the proof of the reverse direction. The next theorem shows flexibility of dividing curves.

Theorem 3.0.23. *Let S be a convex surface with two dividing sets Γ_0 and Γ_1 . Then Γ_0 and Γ_1 are isotopic through curves transverse to S_ξ .*

Theorem 3.0.24 (Giroux flexibility). *Let $i : S \hookrightarrow M$ be an embedding of S into (M, ξ) with convex image. Let \mathcal{F} be a foliation on S divided by $i^{-1}(\Gamma_S)$. Given any neighbourhood U of $i(S)$ in M , there is an isotopy $\phi_s : S \rightarrow M$ supported in U so that $\phi_0 = i$, each $\phi_s(S)$ is convex with dividing set Γ_S , ϕ_s fixes $i^{-1}(\Gamma_S)$ for all s , and $\phi_1(\mathcal{F})$ is the characteristic foliation of $\phi_1(S)$.*

So one can achieve any foliation as a characteristic foliation, once we know the dividing curves dividing the foliation. In particular, the precise characteristic foliation does not matter. Finally we state Legendrian realization principle which will be implicitly used in open book decompositions later. This is originally due to Kanda [45] and proved in full generality by Honda [42]. We say a knot is Legendrian if it is tangent to the contact planes.

Theorem 3.0.25 (Legendrian Realization Principle). *Let $S \subset (M, \xi)$ be a convex surface and let $C \subset S$ be a multicurve which is transverse to Γ_S . Suppose that every component of $S \setminus C$ intersects Γ_S . Then there is an isotopy ϕ_s of S through convex surfaces, supported in an arbitrarily small neighbourhood of S and fixing Γ_S , so that $\phi_s(C)$ is always transverse to Γ_S and $\phi_1(C)$ is Legendrian.*

Using the Legendrian realization principle one can characterize tightness of neighbourhoods of convex surfaces in terms of dividing curves.

Theorem 3.0.26 (Giroux's criterion). *Let $S \subset (M, \xi)$ be a convex closed surface. Then S has a tight neighbourhood if and only if $S = S^2$ and Γ_S is connected or $S \neq S^2$ and Γ_S has no contractible components.*

To do any justice to the far reaching effect of convex surface theory in contact topology would take us too far away from the main topic of this thesis. We just remark that convex surface theory has been used extensively in the classification of tight contact structures.

CHAPTER IV

KNOTS IN CONTACT MANIFOLDS

As in the study of the topology of 3 manifolds, the study of knots plays an important role in the topology of contact 3 manifolds. Recall that given a 3 manifold M , a knot K in M is an embedding $\gamma : S^1 \hookrightarrow M$ such that $Image(\gamma) = K$. In the context of contact 3 manifolds (M, ξ) , one can talk about two different kinds of knots. If the $T_p K \subset \xi_p$ for any part $p \in K$, then we call the knot *Legendrian*. We call a knot K *transverse* if $T_p K$ is transverse to ξ_p for all $p \in K$.

We call two Legendrian knots K_1 and K_2 *Legendrian isotopic* if they are isotopic through Legendrian knots. Similarly we can define transverse isotopy for transverse knots. For the purposes of this thesis we will be working mainly with knots in (S^3, ξ_{std}) which is the one point compactification of $(\mathbb{R}^3, \xi_{std})$ as observed before. This gives a way of visualising Legendrian knots by taking projections in \mathbb{R}^3 . For this we fix a parametrization $\gamma : S^1 \rightarrow \mathbb{R}^3$ which is given by $\theta \mapsto (x(\theta), y(\theta), z(\theta))$. Since $\xi_{std} = ker(dz - ydx)$ and $\gamma'(\theta) \in \xi_{\gamma(\theta)}$ we have $z'(\theta) - y(\theta)x'(\theta) = 0$. Now we talk about the *front projection*.

$$\Pi : \mathbb{R}^3 \rightarrow \mathbb{R}^2 : (x, y, z) \rightarrow (x, z)$$

The image $\Pi(K)$ of K under this map is called front projection of K . Note that $\Pi \circ \gamma$ parametrizes the projection $\Pi(K)$. We also have that $z'(\theta) = y(\theta)x'(\theta)$. Note that x' must never vanish, as vanishing of x' implies $y(\theta) \rightarrow \infty$. So we can conclude that $\Pi(K)$ must not have any vertical tangencies. Note that we can always recover y co-ordinate by setting $y(\theta) = \frac{z'(\theta)}{x'(\theta)}$ as long as x' is not zero. It is easy to convince oneself that for any generic C^1 Legendrian embedding in \mathbb{R}^3 , $x'(\theta)$ can only vanish at isolated points. At these isolated points there is a well defined tangent line in the

front projection. These points are called *cusps*.

The discussion above completely characterizes a Legendrian knot in terms of its front projection, we observe another property of these projections. Note that in a front projection y -axis points into the page. So we conclude that in a front projection the slope of an overcrossing is less than the slope of an undercrossing. We draw a few examples to illustrate front projections below.

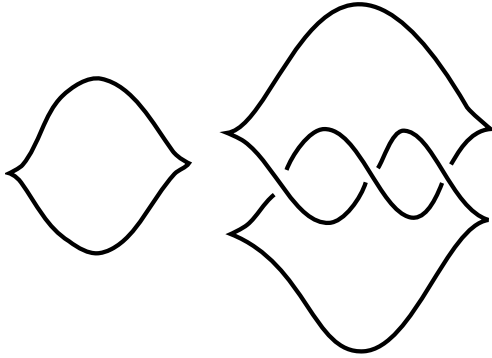

Figure 5: The front projection of a Legendrian unknot on the left and the front projection of a Legendrian right handed trefoil on the right.

Just like in case of smooth knots in S^3 , there is a version of Legendrian Reidemeister moves. But their discussion will lead us far from the main topic of this thesis, so we refer the reader to [21, 31]. We also leave the topic of transverse knots to these references.

4.1 *Classical invariants of Legendrian knots*

The obvious classical invariant of a Legendrian knot K is its knot type. Since a Legendrian isotopy is, in particular a smooth isotopy, this implies that any two isotopic Legendrian knots should be smoothly isotopic.

The second classical invariant is an integer called the Thurston-Bennequin number of a Legendrian knot. Intuitively this integer measures twisting of the contact planes around the knot K . To make this more precise, a trivialization of the normal bundle ν to K is an identification of ν with $K \times \mathbb{R}^2$ and is called the *framing* of the knot

K . Since the contact planes ξ_x and the normal bundle ν_x intersect transversely, we get a line $l_x = \xi_x \cap \nu_x$ for any $x \in K$. The line bundle l gives a canonical choice of normal in the contact planes or in other words a canonical framing. This framing is called the Thurston-Bennequin framing of the knot K . We will denote this by $tb(K)$. Let v be a non-vanishing vector field in $\nu \cap \xi$. Let K' be a copy of K pushed in the direction given by v . Then the Thurston-Bennequin number of K is defined by $tb(K) = lk(K, K')$. Here lk denotes the linking number.

We finally describe the *rotation number* of an oriented null-homologous Legendrian knot. Since the knot is assumed null-homologous it bounds an oriented surface, the so called Seifert surface, Σ . Since any orientable two plane bundle over a surface with boundary is trivial, $\xi|_{\Sigma}$ is a trivial two plane bundle. This trivialization induces a trivialization of $\xi|_K = K \times \mathbb{R}^2$. Now we can let v to be a non-vanishing vector field in the direction of the orientation along the knot and let the rotation number of K be winding number of this vector field.

We mention following important theorem which is fundamental in theory of Legendrian knots.

Theorem 4.1.1 (Eliashberg 1991, [13]). *Let (M, ξ) be a tight contact 3-manifold. Let K be a Legendrian knot in M with Seifert surface Σ_K . Then,*

$$tb(K) + |rot(K)| \leq -\chi(\Sigma_K)$$

Our next goal is to figure out the classical invariants from the front projection of a given Legendrian knot K in $(\mathbb{R}^3, \xi_{std})$. We start by describing the $rot(K)$. Let $w = \frac{\partial}{\partial y}$. We can use this vector field to trivialize ξ_K as this is a non-vanishing section of ξ_{std} . To compute the rotation number we need to find how many times a non-vanishing section v of ξ pointing in the direction of K winds around origin in \mathbb{R}^2 . This is equivalent to how many times v and w point in the same direction. The sign of intersection is defined to be +1 for when v passes w in a counter clockwise fashion

and -1 for clockwise. In the front projection, v and $\pm w$ point in the same direction at the cusps and the intersection is positive when going down and negative when going up. Thus we get that in the front projection

$$rot(K) = \frac{1}{2}(D - U).$$

Here D is the number of down cusps and U is the number of up cusps in the front projection.

Now we try to find a formula for the Thurston-Bennequin number of a Legendrian knot in the front projection. Towards that end, let $w = \frac{\partial}{\partial z}$, a vector field which is transverse to any Legendrian knot in $(\mathbb{R}^3, \xi_{std})$ and in particular to the Legendrian knot K . From the discussion above about the Thurston-Bennequin number, we know that $tb(K) = lk(K, K')$ where K' is a copy of K slightly pushed in the direction given by w . The linking number in this context is just half the signed count of intersection between these copies. The sign convention used is demonstrated in Figure 6.

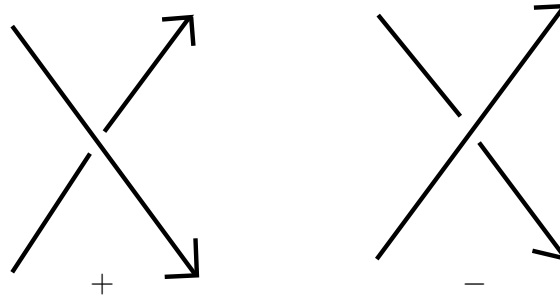

Figure 6: The sign convention used in computing linking numbers in \mathbb{R}^3 . A positive crossing is shown on the left and a negative crossing is shown on the right.

It is straightforward to see that at every positive crossing of the knot K , there will be two positive crossings in the computation of linking number above and similarly for the negative crossing. At the right or left cusps there will be a negative intersection. So we can compute the Thurston-Bennequin number of the knot K from its front projection $\Pi(K)$ as:

$$tb(K) = \text{writhe}(\Pi(K)) - \frac{1}{2}(\text{number of cusps in } \Pi(K)).$$

We now describe an operation on Legendrian knots called stabilization. If a strand of a Legendrian knot K , in a front projection of K is as shown in the middle of the Figure 7, then a positive or negative stabilization of K is obtained by adding "zig-zags" to the strand as shown on the right or left the Figure 7. If down cusps are added we call it the positive stabilization and if up cusps are added then we call it the negative stabilization. We denote positive stabilization by $S_+(K)$ and the negative stabilization by $S_-(K)$. It follows easily from the above definitions of tb and rot that

$$tb(S_{\pm}(K)) = tb(K) - 1$$

and

$$rot(S_{\pm}(K)) = rot(K) \pm 1.$$

Even though we have described stabilization of a knot in terms of front projections, this describes stabilizations of Legendrian knots in any contact 3 manifold. This follows from Darboux's theorem, since the stabilizations are done locally. One should also note that stabilization is a well defined operation. This is not obvious at all. We refer the reader to [23] for the proof. For $(\mathbb{R}^3, \xi_{std})$ it was proved in [28].

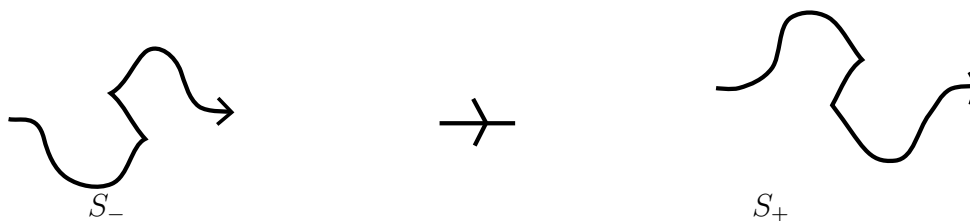

Figure 7: Stabilizing a Legendrian knot in $(\mathbb{R}^3, \xi_{std})$. In the middle we show a strand of a Legendrian knot, the right picture shows adding a down cusp and the left picture shows adding up cusp.

4.2 Surgeries along Legendrian knots

Before describing surgeries along Legendrian knots, we define surgery on smooth knots. Let K be an oriented knot in S^3 . Let νK denote the normal neighbourhood of the knot K in S^3 . Since any orientable D^2 bundle over S^1 is diffeomorphic to $S^1 \times D^2$, we know that νK is diffeomorphic to $S^1 \times D^2$. Let C denote the closure of the complement $S^3 \setminus \nu(K)$. It is a standard fact from algebraic topology that $H_1(T^2) \cong \mathbb{Z} \oplus \mathbb{Z}$. Here we are identifying T^2 with the oriented boundary $\partial\nu(K) \cong \partial(C)$. On T^2 there are two distinguished isotopy classes of curves up to isotopy.

- The meridian μ is defined to be the curve that bounds a disk in $\nu(K)$.
- The preferred longitude λ is the unique (upto isotopy) curve which bounds a surface in C .

An application of the Meyer-Vietoris sequence implies that $H_1(T^2) \cong H_1(\nu(K)) \oplus H_1(C)$. This in turn implies that $H_1(C) \cong \mathbb{Z}$. With the convention above we can characterize this isomorphism by sending $\mu \mapsto (0, 1)$ and $\lambda \mapsto (1, 0)$.

A Dehn surgery along K means that we remove a neighbourhood $\nu(K)$ of K and glue back a solid torus $S^1 \times D^2$ via a diffeomorphism of the boundary torus. If we write μ_0 for the meridian $* \times \partial D^2$ of $S^1 \times D^2$, and λ_0 for the longitude $S^1 \times *$. Then the gluing diffeomorphism can be described by $\mu_0 \mapsto p\mu + q\lambda$, $\lambda_0 \mapsto m\mu + n\lambda$ with

$$\begin{bmatrix} p & m \\ q & n \end{bmatrix} \in GL(2; \mathbb{Z}).$$

It is a standard fact that the effect of Dehn surgery along a knot K is completely described by the image $p\mu + q\lambda$ of μ_0 . It follows that we can talk about a surgery by prescribing the slope $\frac{p}{q} \in \mathbb{Q}$.

The following result shows the importance of studying surgeries along knots and links (embedded copies of the finite disjoint union $\coprod S^1$).

Theorem 4.2.1 (Lickorish [48], Wallace [73]). *Any closed, connected orientable 3-manifold can be obtained from S^3 by surgery along a link.*

Now we introduce the contact structure into the picture. We start by describing a model normal neighbourhood of Legendrian knots. We have the following contact neighbourhood theorem. For the proof see Corollary 2.5.9 of [31].

Theorem 4.2.2 (Contact neighbourhood theorem). *If $K_i \subset (M_i, \xi_i)$, $i = 0, 1$ are diffeomorphic closed Legendrian submanifolds, then they have contactomorphic neighbourhoods.*

Now given any Legendrian knot K in a contact 3 manifold (M, ξ) to describe a model of neighbourhood for K we consider $S^1 \times \mathbb{R}^2$ with the contact form $\alpha = \cos(\theta)dx - \sin(\theta)dy$, where θ is the co-ordinate on S^1 and (x, y) are standard Cartesian co-ordinates on \mathbb{R}^2 . It is easy to see that $L = S^1 \times \{(0, 0)\}$ is a Legendrian knot in this contact manifold. By the contact neighbourhood theorem we have a model neighbourhood of any Legendrian knot K in (M, ξ) given by L in $(S^1 \times \mathbb{R}^2, \xi = \ker(\alpha))$.

One can observe that the radial vector field given by $v = x\partial_x + y\partial_y$ is a contact vector field. Recall that a contact vector field means a vector field whose flow preserves the contact form i.e. $\mathcal{L}_v\alpha = \alpha$ and \mathcal{L} denoting the Lie derivative.

One can also note that the vector field v above is transverse to a torus given by $x^2 + y^2 = \delta$ for any $\delta > 0$, in this standard model $S^1 \times \mathbb{R}^2$ and thus the torus is a convex torus. So we get that a neighbourhood of a Legendrian knot is $S^1 \times D^2$ and whose boundary torus is convex.

The dividing curves are.

$$\Gamma(\theta) := \{(\theta, \pm\delta\sin(\theta), \pm\delta\cos(\theta))\}$$

It is easy to check that v is tangent to ξ along Γ .

We are now in a position to define contact surgery. Let K be a null-homologous Legendrian knot in (M, ξ) . There are two natural framings for this knot: the Seifert framing λ_S and the Thurston-Bennequin framing λ_{tb} . These framings are related by $\lambda_{tb} = tb(K)\mu + \lambda_S$.

Definition 4.2.3 (Contact Surgery). *Let $K \subset (M, \xi)$ be a Legendrian knot. A contact $\frac{p}{q}$ -surgery on K is constructed by performing $\frac{p}{q}$ -surgery on K with respect to the contact framing and extending the contact structure on $\overline{M \setminus N(K)}$ across $S^1 \times D^2$ by a tight contact structure on $S^1 \times D^2$.*

If $\frac{p}{q} = \frac{1}{n}$, then we get a uniquely defined contact structure. To see this, using the gluing diffeomorphism to send $\{*\} \times \partial(D^2)$ to $\mu + n\lambda_{tb}$ and $S^1 \times \{*\}$ to $\mu + (n-1)\lambda_{tb}$, we can see that the curve on $S^1 \times D^2$ sent to λ_{tb} is $(\{*\} \times \partial D^2) - (S^1 \times \{*\})$. Thus the contact structure on $S^1 \times D^2$ has two dividing curves of slope -1 . By the classification due to Kanda [45], there is exactly 1 tight contact structure with this convex boundary. So a $\frac{1}{n}$ contact surgery is uniquely defined. We will only need $\frac{1}{n}$ contact surgery in our discussions in this thesis, so we do not discuss the complications involved in other $\frac{p}{q}$ surgeries.

Definition 4.2.4 (Legendrian Surgery). *A Legendrian surgery on a Legendrian knot $K \subset (M, \xi)$ is a contact (-1) -surgery along K .*

In this context we have the following contact version of the Lickorish-Wallace Theorem. It was proved by Ding and Geiges [9].

Theorem 4.2.5. *Let (M, ξ) be a closed, connected contact 3 manifolds. Then (M, ξ) can be obtained by contact $(\pm)1$ -surgery along a Legendrian link in (S^3, ξ_{std}) .*

CHAPTER V

OPEN BOOK DECOMPOSITIONS

In our discussion of contact manifolds, we have never checked the classes of manifolds that admit contact structures. We address this issue now and on the way introduce the important concept of open book decompositions of contact manifolds, which is a basis for much of work done in this thesis. We start by proving the following theorem which states that any closed, oriented 3 manifold admits a contact structure. It was originally proved by Martinet [57]. We give a proof here due to Thurston and Wilkhnkemper [70]. Before giving the proof of the theorem we make an important definition.

Definition 5.0.6 (Open Book Decomposition). *An open book decomposition for a closed, oriented 3 manifold M is a pair (L, π) where, L is an oriented link in M called the binding and π is a fibration of the link complement $\pi : M \setminus L \rightarrow S^1$ such that the fiber $S_\theta = \overline{\pi^{-1}(\theta)}$ for any $\theta \in S^1$ is an oriented surface diffeomorphic to a fixed surface S , with $\partial S_\theta = L$. The fibers S_θ are called the pages of open book decomposition.*

Note that $M \setminus \nu(L)$ being a fibration over S^1 , can be written as a mapping torus

$$M_\phi = \frac{S \times [0, 1]}{(x, 1) \sim (\phi(x), 0)}$$

for a diffeomorphism $\phi : S \rightarrow S$, such that ϕ is isotopic to identity on a neighbourhood of ∂S . One way to see this is as follows. Note that any fibration over the interval $[0, 1]$ is trivial as $[0, 1]$ is contractible. We also know that $M \setminus \nu(L)$ is obtained from a fibration $S \times [0, 1]$ over $[0, 1]$ by identifying the ends $S \times \{0\}$ and $S \times \{1\}$. The identification is given by the diffeomorphism ϕ of the compact surface S . Now the

fibers being pages of the open book decomposition puts a restriction that ϕ is isotopic to identity on a neighbourhood of the boundary of S .

It is clear that all we need to know to describe the open book decomposition is the surface S and the diffeomorphism ϕ .

Definition 5.0.7 (Abstract open book decomposition). *An abstract open book decomposition of a closed, orientable, connected manifold M is a pair (S, ϕ) such that S is a surface with non-empty boundary and ϕ is a diffeomorphism of S restricting to identity in a neighbourhood of ∂S , and M is diffeomorphic to*

$$M_\phi \cup_\psi (\partial S \times D^2)$$

Here M_ϕ being the mapping torus and the map ψ is given as follows. For each boundary component l of S , the map $\psi : \partial(S^1 \times D^2) \rightarrow l \times S^1 \subset M_\phi$ is defined to be a unique up to isotopy diffeomorphism that takes $S^1 \times \{p\}$ to l where $p \in \partial D^2$ and $\{q\} \times \partial D^2$ to $(\{q'\} \times [0, 1] / \sim) \cong S^1$.

The map ϕ in the definition above is called the monodromy of the open book decomposition and the surface S is called the page of the open book decomposition.

Theorem 5.0.8. *Every closed, oriented 3-manifold M admits a contact structure.*

Proof. Alexander showed in the 1920s that any closed, oriented 3 manifold M admits an open book decomposition as defined above. We will construct a contact form on $M \setminus \nu(L)$ and then show how to extend it over the binding.

Now since S is an oriented compact surface, we let ω be an area form on S with total area given by $2\pi|\partial S|$ and $\omega = dt \wedge d\theta$ on a neighbourhood $[0, 1] \times S^1$ of each boundary component of S . Here t denotes the parameter on $[0, 1]$, θ denotes the variable on S^1 and $|\partial S|$ denotes the number of boundary components (≥ 1) of S . Let α be a 1-form on S which is equal to $(1 + t)d\theta$ near boundary ∂S . Note that $\omega - d\alpha$ vanishes near ∂S . Also note that,

$$\int_S \omega - d\alpha = 2\pi|\partial S| - \int_{\partial S} \alpha = 0.$$

Note that we have used the fact that $t = 0$ on the boundary ∂S in the above computation. It follows from De Rham's theorem that $\omega - d\alpha = d\beta$ for some 1-form β which vanishes on the neighbourhood of the boundary. Let $\lambda = \alpha + \beta$. This has the property that $\lambda = \alpha$ near the boundary and $d\lambda = \omega$. One can easily check that the set of 1-forms λ satisfying these conditions is non-empty and convex. It is also easy to check that if λ is in this convex set then so is $\phi^*\lambda$. Here ϕ is the monodromy as defined above. Now define a 1-form on the mapping torus by $\lambda_s = s\lambda + (1-s)\phi^*\lambda$ and set $\alpha_\phi = \lambda_s + Kds$. Then $\alpha_\phi \wedge d\alpha_\phi = Kd\lambda_s \wedge ds$. This is a volume form for large enough K as $d\lambda_s$ is an area form on S_s . Moreover, $\alpha_\phi = (1+t)d\theta + Kds$ near ∂M_ϕ . To finish the construction we need to find a contact structure on solid torus $D^2 \times S^1$ which is equal to $-(1+t)d\theta + Kd\psi$ near the boundary. Here $r = 1+t$. Here (r, ψ) are co-ordinates on D^2 and θ is the co-ordinate on S^1 . Near center of D^2 we take the contact form $\alpha = d\theta + r^2d\psi$ and in between we take $\alpha = f(r)d\theta + g(r)d\psi$. The contact condition then becomes $fg' - g'f > 0$ with $(f, g) = (1, r^2)$ near $r = 0$ and $(f, g) = (-r, K)$ near $r = 1$. One can easily find functions f and g satisfying these properties. Hence, we have extended the contact form α from mapping torus M_ϕ to the closed manifold M .

□

It turns out that not only does any closed, oriented 3 manifold admits a contact structure, it admits infinitely many contact structures.

Theorem 5.0.9. *Every cooriented tangent 2-plane field on a closed, orientable 3-manifold is homotopic to a contact structure. In particular, for any even element $e \in H^2(M; \mathbb{Z})$ there is a contact structure ξ on M with the Euler class of the contact structure $e(\xi) = e$.*

The contact structures arising out of the construction of Thurston and Wilkinkemper are special.

Definition 5.0.10. *A contact structure ξ on a closed, oriented 3-manifold is said to be supported by the open book decomposition (L, π) of M , if there is a 1-form α such that $\xi = \ker(\alpha)$ and*

- *The 2-form $d\alpha$ induces an area form on each page defining the orientation on S and inducing the given orientation on L .*
- *The 1-form α induces a positive volume form on $L = \partial S$.*

Example 5.0.11. *Consider S^3 as the unit sphere in \mathbb{C}^2 with the standard contact form $\alpha = r_1^2 d\phi_1 + r_2^2 d\phi_2$ where $(r_1, \phi_1, r_2, \phi_2)$ are polar coordinates on \mathbb{C}^2 . We set the binding to be $L = \{(z_1, z_2) \in \mathbb{C}^2 \mid z_1 = 0\}$ and consider the fibration*

$$\pi : S^3 \setminus L \rightarrow S^1 \subset \mathbb{C}$$

$$(z_1, z_2) \mapsto \frac{z_1}{|z_1|}$$

This is equivalent to the map $(r_1 e^{i\phi_1}, r_2 e^{i\phi_2}) \mapsto \phi_1 \in S^1$. This shows that (L, π) is an open book decomposition with disk pages given by $\{|z_2| < 1 : z_1 = \sqrt{1 - |z_2|^2} e^{i\phi_1}\}$ and monodromy map given by identity. It is easy to see that the contact 1-form α restricts to $d\phi_2$ along L and $d\alpha$ to $r_2 dr_2 \wedge d\phi_2$ along the pages.

Example 5.0.12. *Consider S^3 and α as above. Set $L' = \{(z_1, z_2) \in S^3 : z_1 z_2 = 0\}$. This set L' is the union of two knots $K_i = \{(z_1, z_2) \in S^3 : z_i = 0\}, i = 1, 2$. We think of K_i as boundary of the disk $D_i = \{(z_1, z_2) \in D^4 : z_i = 0\}, i = 1, 2$. The link $L' = K_1 \cup K_2$ is called the positive Hopf link. Consider the fibration given by*

$$\pi' : S^3 \setminus L' \rightarrow S^1$$

$$(z_1, z_2) \mapsto \frac{z_1 z_2}{|z_1 z_2|}.$$

In polar co-ordinates this is given by $\pi' : (r_1 e^{i\theta_1}, r_2 e^{i\theta_2}) \mapsto \theta_1 + \theta_2$. One can easily see that this open book supports the contact structure $(S^3, \xi = \ker(\alpha))$ where $\alpha = r_1^2 d\phi_1 + r_2^2 d\phi_2$. It takes a bit more effort to show that open book decomposition is given by an annulus and the monodromy of this open book decomposition is the diffeomorphism given by the right handed Dehn twist about the core of the annulus.

It is easy to see from the proof of Theorem 5.0.8, that the contact structure constructed there is supported by the open book decomposition. Now we know that given an open book decomposition, one can find a contact structure ξ supporting it. The next proposition proves that this contact structure is essentially unique. We follow the proof from [31].

Proposition 5.0.13. *Let ξ_1 and ξ_2 be contact structures supported by the same open book decomposition (L, π) . Then ξ_1 is isotopic to ξ_2 .*

Proof. Let α_1, α_2 be contact forms representing ξ_1, ξ_2 , respectively. Let $\partial S \times D_\epsilon^2$ be a neighbourhood of the binding. In terms of coordinates (θ, r, ϕ) on a neighbourhood of any binding component we have $\alpha_i(\frac{\partial}{\partial \theta}) > 0$. Now choose a function $f(r)$ such that $f(0) = 0, f' \geq 0, f(r) = r^2$ near $r = 0$ and $f \equiv 1$ outside $\partial S \times D_{\epsilon/2}^2$. For any $R > 0$, let

$$\alpha_{i,R} = \alpha_i + Rf(r)d\phi.$$

Then it is easy to compute $\alpha_{i,R} \wedge d\alpha_{i,R} = \alpha_i \wedge d\alpha_i + Rf(r)d\phi \wedge d\alpha_i + Rf'(r)\alpha_i \wedge dr \wedge d\phi$. By the orientation assumptions it is easy to check that this defines a contact form for any $R \geq 0$. Now Gray's theorem implies that for a fixed i , $\ker(\alpha_{i,R})$ are all isotopic contact structures.

Observe that $f(r)d\phi \wedge d\alpha_{i,R} > 0$ away from the binding and $\alpha_i \wedge f'(r)dr \wedge d\phi > 0$ near binding. Now it is straightforward to compute that $(1-t)\alpha_{1,R} + t\alpha_{2,R}$ is a contact form for any $t \in [0, 1]$ for large enough R . Then again Gray's theorem implies that ξ_1 and ξ_2 are isotopic as contact structures.

□

Definition 5.0.14 (Contact cell decomposition). *A contact cell decomposition of (M, ξ) is a CW-decomposition of M such that the 1-skeleton is Legendrian and each 2-cell D satisfies $tw(\partial D, D) = -1$ and the restriction of ξ to any 3-cell is tight.*

The natural question is, does any contact 3 manifold admit a contact cell decomposition? The next proposition shows exactly this.

Proposition 5.0.15. *Let (M, ξ) be a closed contact 3-manifold. Then (M, ξ) admits a contact cell decomposition.*

Proof. The manifold M being compact implies that we can cover M with finitely many Darboux balls. We can take a triangulation T that is fine enough so that every 3-cell is contained in a Darboux 3 ball. Then a C^0 perturbation of 1-skeleton is Legendrian. We need to prove that $tw(\partial D, D) = -1$. The Thurston-Bennequin inequality given in Theorem 4.1.1, tells us that $tw(\partial D, D) \leq -1$ for each 2-cell. It is a theorem of Kanda [46], that if Σ is any surface in a contact 3 manifold (M, ξ) with Legendrian boundary satisfying $tw(\gamma, \Sigma) \leq 0$ for all boundary components γ , then Σ may be C^0 small perturbed near the boundary and then C^∞ perturbed on the interior so as to become convex. So we can perturb D to make it convex. Now if some face satisfies $tw(\partial D, D) < -1$, then since D lives in a Darboux ball its dividing set Γ_D consists of $-tw(\partial D, D) \geq 2$, properly embedded arcs. We can find non-isolating multicurve $C \subset D$ such that each component of $D \setminus C$ contains exactly 1 component of Γ_D . By Legendrian realization principle we can make C Legendrian. We add C to the 1-skeleton. This splits D into convex faces D_i such that $tw(\partial D_i, D_i) = -1$. □

The 1-skeleton of a contact cell decomposition is a Legendrian graph G . Given a graph like this one can find a surface S embedded in M such that G is a retract of S . One can moreover arrange that $T_p S = \xi_p$ if and only if $p \in G$. We let $L = \partial S$ and

impose the condition that L is a transverse link. A surface satisfying these conditions is called the ribbon of G .

Now the first step in proving the Giroux correspondence is to prove that L is the binding of an open book decomposition of M with pages S . Then one proves that this open book indeed supports with (M, ξ) . Proving any of these propositions will take us far from the topic of this thesis. Instead we refer the reader to [22] for their proof. With this set up we can state one of the main results which we will use in this thesis.

Theorem 5.0.16. *Given any Legendrian knot $K \subset (M, \xi)$, there is an open book decomposition (L, π) such that L lies on one of the pages S_θ such that the framing given by the page and the contact structure ξ agree.*

Proof. Since K is a Legendrian knot, we can form a contact cell decomposition of (M, ξ) which contains K in its 1-skeleton G . Then the Giroux's construction proves that L sits on a page of an open book decomposition supporting ξ .

□

Definition 5.0.17. *Let (S, ϕ) be an abstract open book decomposition supporting (M, ξ) . A positive stabilization of (S, ϕ) is an open book decomposition of the form (S', ϕ'_{τ_c}) , where S' is obtained from S by attaching a 1-handle h along its boundary and τ_c is a right handed Dehn twist along a curve $c \subset S'$ which intersects co-core of h exactly once.*

Proposition 5.0.18. *Let (S', ϕ') be a positive stabilization of (S, ϕ) . Then both (S', ϕ') and (S, ϕ) support the same contact structure.*

Sketch of proof. We define the notion of plumbing of open books first. Let $O_1 = (S_1, \phi_1)$ and $O_2 = (S_2, \phi_2)$ be two open books. The plumbing of these open books, denoted $O_1 * O_2$ is defined as follows: Let $a_i \subset S_i, i = 1, 2$ be two properly embedded

arcs with product neighbourhoods $R_i = a_i \times I$. Then $O_1 * O_2$ is an open book decomposition with page $S = S_1 \cup_{R_1=R_2} S_2$ glued together by a diffeomorphism so that $a_i \times \{-1, 1\} = \partial a_{i+1} \times [-1, 1]$ and the monodromy is $\phi_1 \circ \phi_2$. It is possible to see that the plumbing supports a contact structure on manifold obtained by the connect sum of contact manifolds.

It can be proved that positive stabilization is the same as the plumbing of the existing open book with the one given by (A, τ) , where A is an annulus and τ is the Dehn twist about the core of the annulus. As seen in Example 5.0.12 above (A, τ) supports the standard contact structure on S^3 . Connect summing with (S^3, ξ_{std}) does not change the contact structure. So we see that positive stabilization preserves the contact structure.

□

Theorem 5.0.19 (Giroux). *Any two open books supporting (M, ξ) are related by positive stabilizations.*

We will need a way of stabilizing a knot on the page of the open book decomposition. It is shown in the Figure 8.

The proof of this fact is easy to see, once we realise that the core curve of the Hopf band gets a framing of -1 from the page.

One last piece we will need in our proofs of the classification of certain symplectic fillings is the following theorem that relates the Legendrian surgery to open book decompositions.

Theorem 5.0.20. *Let (S, ϕ) be an open book decomposition supporting (M, ξ) . If L is a Legendrian knot sitting on a page of this open book decomposition so that the contact framing and the page framing agree, then the contact manifold (M', ξ') obtained by performing contact $(\pm)1$ surgery along L is supported by open book decomposition $(S, \phi \circ \tau_L^{\mp})$*

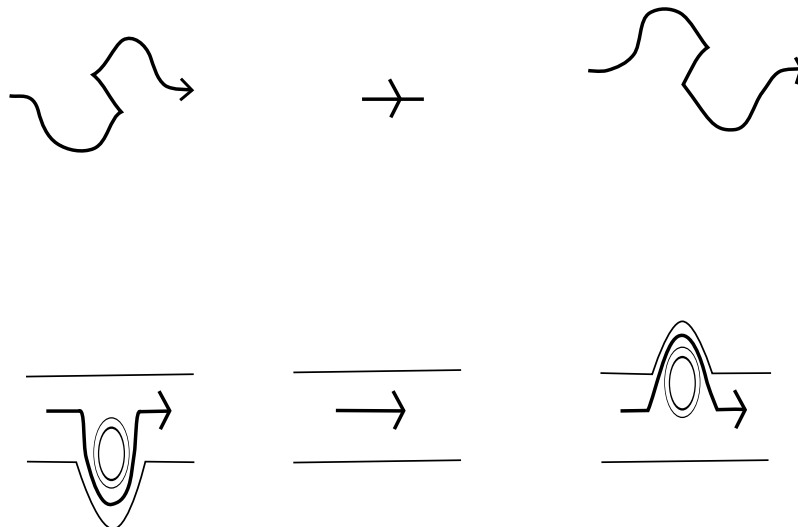

Figure 8: Stabilizing a Legendrian knot on the page of an open book decomposition. In the middle we show a Legendrian knot sitting on a page of open book decomposition, the right picture shows a positive stabilization of the knot and the left picture shows a negative stabilization of the knot.

It is not too hard to see that topologically the manifold given by the new open book decomposition $(S, \phi \circ \tau_L^\mp)$, is obtained by ± 1 surgery along L . We just need to check the contact structure is the one given by the Legendrian surgery. We refer the reader to [22] for a detailed proof.

We finally mention that notion of open book has been extended to a more general class by Lisi, Van Horn-Morris and Wendl. We briefly sketch the important ideas.

A spinal open book is a generalization of the standard open book decomposition where the binding is allowed to be $\coprod_1^n (S^1 \times \Sigma_i)$ where Σ_i can be any surface with boundary. In a standard open book decomposition the binding is $\coprod_1^m (S^1 \times D^2)$. An abstract spinal open book is given by a 5-tuple $(M, \hat{F}, \hat{\phi}, \hat{\Sigma}, G)$. Here M is the 3-manifold, \hat{F} is the fiber (can be disconnected), $\hat{\phi}$ is orientation preserving diffeomorphism of \hat{F} fixing boundary pointwise, $\hat{\Sigma} \times S^1$ is the binding and G is a bijection taking $\partial \hat{F}$ to $\partial \hat{\Sigma}$. If the contact manifold is fixed we will just denote the supporting spinal open book decomposition by $(\hat{F}, \hat{\phi}, \hat{\Sigma}, G)$. Roughly speaking, spinal open books provide the right contact boundary for Lefschetz fibrations over non disk bases.

One constructs the original manifold back from this data as follows. Form a surface bundle over S^1 with fiber \hat{F} and monodromy $\hat{\phi}$ and the trivial bundle $S^1 \times \hat{\Sigma}$. We glue the resulting boundaries together by the bijection G to identify the components in such a way that the oriented boundary of a fiber \hat{F} is a collection of S^1 fibers in $S^1 \times \hat{\Sigma}$. It is also known that spinal open books under additional restrictions support a unique contact structure. For the purposes of this thesis, we will assume that the $\hat{F}, \hat{\Sigma}$ are both connected.

We refer the reader to articles [53, 5] for details on spinal open books.

CHAPTER VI

MAPPING CLASS GROUPS

In this section we recall basic notions from mapping class groups. We refer the reader to [26] for more comprehensive introduction and proofs of results stated here. Let $(S, \partial S)$ be a pair such that S is a compact, orientable surface with boundary ∂S . The mapping class group of the pair $(S, \partial S)$ is defined by

$$\text{Map}(S, \partial S) = \pi_0(\text{Diffeo}^+(S, \partial S)).$$

Here $\text{Diffeo}^+(S, \partial S)$ denotes the set of orientation preserving diffeomorphisms of S fixing the set ∂S pointwise. The set $\text{Map}(S, \partial S)$ forms a group under composition. In other words $\text{Map}(S, \partial S)$ is the group of isotopy classes of elements of $\text{Diffeo}^+(S, \partial S)$, where isotopies fix the set ∂S pointwise.

A few examples are in order. The first example is that of a closed disk \mathbb{D}^2 . It is not too hard to see that $\text{Map}(\mathbb{D}^2, \partial\mathbb{D}^2)$ is trivial. The second example is that of an annulus. Let A denote an annulus, then $\text{Map}(A, \partial A) \cong \mathbb{Z}$. The mapping class group of the annulus is generated by a particular diffeomorphism called the Dehn twist. We proceed to define Dehn twist now.

Definition 6.0.21 (Dehn Twist). *Let A denote the annulus $S^1 \times [0, 1]$ with co-ordinates (θ, t) . Let $T : A \rightarrow A$ denote the twist map which can be written in terms of the above co-ordinates as $T(\theta, t) = (\theta + 2\pi t, t)$. It is easy to see that T is an orientation preserving diffeomorphism of A which restricts to identity on the boundary. This defines a Dehn twist on an annulus. For an arbitrary surface S and α a closed, embedded curve in S , choose N to be a regular neighbourhood of α . The neighbourhood N is orientation preserving diffeomorphic to an annulus. Denote the diffeomorphism*

by ϕ . We get the Dehn twist about α as:

$$\tau_\alpha(x) = \begin{cases} \phi \circ T \circ \phi^{-1} & \text{if } x \in N \\ x & \text{if } x \in S \setminus N \end{cases}$$

From the definition it is clear that the Dehn twist is identity outside the neighbourhood N of the curve α . The isotopy class of the Dehn twist does not change by an isotopy of the curve. So we can talk about the Dehn twist of an isotopy class of curves without ambiguity. We now collect a few basic facts about intersection numbers and Dehn twists. We refer the reader to Chapter 3 of [26] for the proofs of these facts.

Fact 6.0.22. *Let a and b be arbitrary isotopy classes of essential simple closed curves on a surface and let k be any integer. Then,*

$$i(\tau_a^k(b), b) = |k|i(a, b)^2$$

Here i denotes the geometric intersection number. Given any two curves α and β we will assume that they are in minimal position i.e. α and β have been isotoped so that they intersect minimally.

From this it is easy to see that Dehn twists have infinite order in the mapping class group and in particular that Dehn twists are non-trivial elements of mapping class groups.

Fact 6.0.23. *Let $\{a_1, a_2, \dots, a_n\}$ be a collection of pairwise disjoint simple closed curves on a surface and let $M = \prod_{i=1}^n \tau_{a_i}^{e_i}$. Suppose $e_i > 0$ for all i or $e_i < 0$ for all i . If b and c are arbitrary simple closed curves, then*

$$|i(M(b), c) - \sum_{i=1}^n |e_i|i(a_i, b)i(a_i, c)| \leq i(b, c)$$

After these facts about intersection numbers, we collect some basic facts about Dehn twists.

Fact 6.0.24. *Given any two curves a and b , $\tau_a = \tau_b$ if and only if $a = b$.*

Fact 6.0.25. *For any element f of a mapping class group of a surface and any simple closed curve a in S*

$$\tau_{f(a)} = f\tau_a f^{-1}$$

Fact 6.0.26. *For any element f of a mapping class group of a surface and any simple closed curve a in S , f commutes with τ_a if and only if $f(a) = a$.*

It is not clear till now whether the mapping class group of a surface is finitely generated or not. This is given to us by the following theorem. Let $S_{g,n}^r$ denote an orientable surface of genus $g \geq 0$, with $n \geq 0$ boundary components and $r \geq 0$ punctures.

Theorem 6.0.27. *The mapping class group of $S_{g,n}^r$ is finitely generated by Dehn twists.*

This theorem for closed surfaces is due to Dehn and Lickorish. We refer the reader to [26] for the proof of this theorem. In fact more is true, the mapping class group is a finitely presented group. An explicit set of generators for mapping class group is given in [72]. For the purposes of this thesis we will need to know explicit presentation only for planar surface (i.e. surface of genus 0) with a finite number of boundary components. For this we use an explicit presentation given by [56]. We proceed to describe the presentation now. In the following discussion \mathbb{D}_n will denote a disk with n open disks removed from interior.

We assume the boundary components are arranged at vertices of a regular n -gon. We call a curve convex, if it is isotopic to the boundary of a convex hull of a collection of boundary components. A Dehn twist about a convex curve is called convex Dehn twist. According to [56], the mapping class group of \mathbb{D}_n is generated by convex twists. The relations are given by

1. Let \mathcal{A} and \mathcal{B} be convex curves and $\tau_{\mathcal{A}}, \tau_{\mathcal{B}}$ denote convex Dehn twists about them. Then $\tau_{\mathcal{A}}\tau_{\mathcal{B}} = \tau_{\mathcal{B}}\tau_{\mathcal{A}}$ if and only if \mathcal{A} is disjoint from \mathcal{B} .
2. **Lantern relations** $\tau_{\mathcal{A}}\tau_{\mathcal{B}}\tau_{\mathcal{C}}\tau_{\mathcal{A}\cup\mathcal{B}\cup\mathcal{C}} = \tau_{\mathcal{A}\cup\mathcal{B}}\tau_{\mathcal{B}\cup\mathcal{C}}\tau_{\mathcal{A}\cup\mathcal{C}}$, where $\mathcal{A}, \mathcal{B}, \mathcal{C}$ are disjoint collection of boundary components and Dehn twists are convex Dehn twist about them. In addition, we require that the boundary components are ordered such that the cyclic clockwise ordering of boundary components in \mathcal{A} followed by those in \mathcal{B} followed by those in \mathcal{C} induces the the cyclic clockwise ordering of boundary components in $\mathcal{A} \cup \mathcal{B} \cup \mathcal{C}$.

6.0.1 Nielsen-Thurston classification of surface diffeomorphisms

One of the major results in mapping class group theory is the Nielsen-Thurston classification of surface diffeomorphisms. We state the result first and then define the terms involved.

Theorem 6.0.28 (Nielsen-Thurston). *Let $g, n \geq 0$ and S_g^n denote a genus g surface with n punctures. Each $f \in \text{Map}(S_g^n)$ is either periodic, reducible or pseudo-Anosov. Furthermore, pseudo-Anosov mapping classes are neither periodic nor reducible.*

We now proceed to define the different kinds of mapping classes.

Definition 6.0.29 (Periodic mapping classes). *A periodic element of the mapping class group is an element that has finite order.*

Definition 6.0.30 (Reducible mapping classes). *An element $f \in \text{Map}(S)$ is called reducible if there is a nonempty set $\{c_1, c_2, \dots, c_n\}$ of disjoint essential simple closed curves such that $\{f(c_i)\} = \{c_i\}$. The collection of the curves is called the reduction system for f .*

Examples of reducible mapping classes are given by Dehn twists. Note that any Dehn twist about an essential simple closed curve α fixes at least α .

Now we define the pseudo-Anosov mapping class element. Before defining we introduce the notion of measured foliation.

Let \mathcal{F} be a (singular)foliation on a surface S . Let α and β be smooth arcs in S transverse to \mathcal{F} . Here transverse arc means that the arc misses the singular points and the arc is transverse to leaves of \mathcal{F} at each interior point.

A *leaf preserving isotopy* from α to β is a map $H : I \times I \rightarrow S$ such that

- $H(I \times \{0\}) = \alpha$ and $H(I \times \{1\}) = \beta$.
- $H(I \times \{t\})$ is transverse to \mathcal{F} for all $t \in [0, 1]$.
- Each arc $H(\{0\} \times I)$ and $H(\{1\} \times I)$ is contained in a single leaf of \mathcal{F} .

A *transverse measure* μ on the foliation \mathcal{F} is a function that assigns a positive real number to each smooth arc transverse to \mathcal{F} such that μ is invariant under a leaf preserving isotopy and μ is regular with respect to the Lebesgue measure.

A measured foliation (\mathcal{F}, μ) on a surface S is a singular foliation \mathcal{F} of S equipped with a transverse measure μ . We say two measured foliations (\mathcal{F}_1, μ_1) and (\mathcal{F}_2, μ_2) are transverse if the leaves of the foliations are transverse away from the singularities.

Now we are finally ready to define pseudo-Anosov mapping class elements. Here we restrict to either closed surfaces or surfaces with punctures. An element $f \in Map(S)$ is called pseudo-Anosov if the surface admits two transverse measures foliations, the stable foliation (\mathcal{F}_s, μ_s) and the unstable foliation (\mathcal{F}_u, μ_u) , on S , and there is a number $\lambda > 1$ called the stretch factor of f and a homeomorphism ϕ isotopic to a representative of f , such that

$$\phi \circ (\mathcal{F}_u, \mu_u) = (\mathcal{F}_u, \lambda \mu_u),$$

$$\phi \circ (\mathcal{F}_s, \mu_s) = (\mathcal{F}_s, \lambda^{-1} \mu_s).$$

The map ϕ is called a pseudo-Anosov homeomorphism. This map is a diffeomorphism away from the singularities of stable and unstable foliations. The definition of

pseudo-Anosov homeomorphism is not natural for surfaces with boundary. So when thinking about pseudo-Anosov homeomorphism for surfaces with boundary we think of it as homeomorphism that restricts to a pseudo-Anosov homeomorphism of surface with punctures obtained by filling the boundary components with disks with punctures.

In the proof of one of our theorems we will use an explicit construction of pseudo-Anosov homeomorphism due to Thurston [71, 26]. We state the theorem here. In our theorems we will use only the last part of this theorem.

Theorem 6.0.31 (Thurston). *Suppose A and B are multicurves in S such that $A \cup B$ fill the surface S . There is a real number μ and a representation $\rho : \langle \tau_A, \tau_B \rangle \rightarrow PSL(2; \mathbb{R})$ given by*

$$\tau_A \mapsto \begin{bmatrix} 1 & \mu^{1/2} \\ 0 & 1 \end{bmatrix}, \tau_B \mapsto \begin{bmatrix} 1 & 0 \\ \mu^{1/2} & 1 \end{bmatrix}$$

such that

- *An element $f \in \langle \tau_A, \tau_B \rangle$ is periodic, reducible, or pseudo-Anosov according to whether $\rho(f)$ is elliptic, parabolic, or hyperbolic.*
- *When $\rho(f)$ is parabolic f is a multitwist.*
- *When $\rho(f)$ is hyperbolic, the stretch factor of f is equal to the larger of the two eigenvalues of $\rho(f)$.*

In the special case when A and B are single curves α and β respectively, the number μ is equal to $i(\alpha, \beta)^2$.

One would hope that the open book supporting a contact structure should carry the information about tightness or overtwistedness explicitly in terms of the page and the monodromy. In particular, information about the action of the monodromy on the surface (which is a page of the open book decomposition), should have some

information about the overtwistedness of the manifold. This is given by following characterization due to Honda, Kazez and Matic [43].

First we define the notion of right veering open books. Let S be a surface with boundary and $\phi \in \text{Map}(S, \partial S)$ a diffeomorphism which fixes the boundary. We call ϕ right veering if for every $x \in \partial S$ and every properly embedded arc α on S with an end point at x , after isotoping $\beta = \phi(\alpha)$, fixing the end points, to intersect α transversely and minimally, the vectors $\beta'(0), \alpha'(0)$ form an oriented basis for $T_x S$.

Theorem 6.0.32 (Honda-Kazez-Matic). *A contact manifold (M, ξ) is tight if and only if every supporting open book is right veering.*

The notion of right veering is relevant to us because of the following important theorem.

Theorem 6.0.33 (Honda-Kazez-Matic). *The set $\text{Veer}(S, \partial S)$ of right veering diffeomorphisms of the surface is a monoid under composition. Moreover, every right handed Dehn twist is right veering.*

CHAPTER VII

SYMPLECTIC FILLINGS OF CONTACT MANIFOLDS

We finally begin our study of symplectic fillings of contact manifolds. The notion of symplectic fillings require definition of symplectic manifolds. In our study of symplectic fillings there is a nice interaction between symplectic manifolds with boundary and Lefschetz fibrations with boundary. We start by describing generalities of symplectic manifolds and Lefschetz fibration in the first subsection.

7.1 Symplectic manifolds and Lefschetz fibrations

Let M be a $2n$ dimensional manifold. A symplectic form ω on M is a closed (i.e. $d\omega = 0$), nondegenerate differential 2-form such that $\omega^n \neq 0$. In other words, ω^n is a volume form on M . The 2-form ω is called a symplectic structure on M . We give a few examples of symplectic manifolds.

Example 7.1.1. On \mathbb{R}^{2n} with co-ordinates $(x_1, y_1, x_2, y_2, \dots, x_n, y_n)$, let

$$\omega_{std} = \sum_{i=1}^n dx_i \wedge dy_i.$$

It is easy to check that $d\omega_{std} = 0$ for this 2-form. It is a simple linear algebra exercise to check the nondegeneracy of ω .

An analogous statement of Darboux theorem holds for symplectic manifolds.

Theorem 7.1.2 (Symplectic Darboux theorem). *Let (M^{2n}, ω) be a symplectic manifold. Then any point $p \in M$ has a neighbourhood U such that there is a diffeomorphism $\phi : V \rightarrow U$, where V an open set in \mathbb{R}^{2n} , such that $\phi^*(\omega) = \sum_{i=1}^n dx_i \wedge dy_i$.*

The content of the Darboux theorem is that, any symplectic manifold is locally symplectomorphic to $(\mathbb{R}^{2n}, \omega_{std})$.

Any volume form on a surface is a symplectic form. So we know that all surfaces admit a symplectic forms. One can ask whether every even dimensional manifolds admit symplectic structures. The answer is no, as shown by following example.

Example 7.1.3. *Let S^4 denote the 4-dimensional unit sphere. As is well known, $H^2(M) = 0$. So if there was a 2 form ω such that $d\omega = 0$, that would imply that ω is also exact i.e. there is a 1-form λ such that $d\lambda = \omega$. So now the volume of sphere is given by $\int_{S^4} \omega \wedge \omega = \int_{S^4} d\lambda \wedge d\lambda = \int_{S^4} d(\lambda \wedge d\lambda) = \int_{\partial S^4} \lambda \wedge d\lambda = 0$. A contradiction. So S^4 does not admit a symplectic structure.*

In the light of this example, one would hope that there is a characterization of manifolds that admit a symplectic structure. The characterization, is given in terms of Lefschetz fibrations. We define Lefschetz fibrations for the special case of 4 manifolds below. First we define a few notions which will be needed later on.

Definition 7.1.4. *Given a $2n$ dimensional manifold M , an almost complex structure J on M is an automorphism $J : TM \rightarrow TM$ such that $J^2 = -Id$ on the tangent space $T_p M$ for every $p \in M$. We denote the space of almost complex structures on a manifold M by $\mathcal{J}(M)$.*

Given a symplectic manifold (M, ω) , an almost complex structure $J \in \mathcal{J}(M)$ is called compatible with ω if, $\omega(Jv, Jw) = \omega(v, w)$ for all $v, w \in T_p M$ and $\omega(v, Jv) > 0$ for all $0 \neq v \in T_p M$. If only the second condition holds then the almost complex structure J is called ω -tame. If J is a compatible almost complex structure then $g_J(v, w) = \omega(v, Jw)$ defines a metric on M . We denote the space of compatible almost complex structures by $\mathcal{J}(M, \omega)$ and the tame almost complex structures are denoted by $\mathcal{J}_\tau(M, \omega)$. The following is an important theorem which we record for the sake of completeness here.

Theorem 7.1.5 (See [61]). *The spaces $\mathcal{J}_\tau(M, \omega)$ and $\mathcal{J}(M, \omega)$ are both non empty and contractible.*

As with any study of manifolds, we will see that study of submanifolds of symplectic manifolds will play an important role in our discussion. We define the two important notions:

Definition 7.1.6. *A submanifold S of a symplectic manifold (X, ω) is*

1. **Lagrangian:** *If $\dim(S) = \frac{1}{2}\dim(X)$ and $\omega|_S = 0$.*
2. **Symplectic:** *If $\omega|_S$ is non degenerate.*

Definition 7.1.7. *Let M^4 be a 4 dimensional manifold and S be a compact surface (possibly with non-empty boundary). Then a Lefschetz fibration is a smooth locally trivial fibration $\pi : M \rightarrow S$, with finitely many isolated critical values $p_1, p_2, \dots, p_n \subset \text{int}(S)$. Each critical point of π has an orientation preserving chart on which π is given by $\pi(z_1, z_2) = z_1 z_2$. For $t \neq p_1, \dots, p_n$, the fiber $F_t = \pi^{-1}(t)$ is called a regular fiber. Otherwise it is called singular fiber.*

Note that in a local co-ordinate chart around each critical point, the unique critical value is 0 and $\pi^{-1}(0) = \{(z_1, z_2) : z_1 = 0 \text{ or } z_2 = 0\}$ is a pair of intersecting planes. This is called the *nodal singularity*. Thus each singular fiber is an immersed surface and each critical point corresponds to a positive transverse self intersection. The nearby fibers which are all non-singular are obtained from the singular fiber by resolving the intersection. Here by resolving the intersection we mean removing the intersecting disks and replacing them with an annulus $z_1 z_2 = t$. Equivalently each singular fiber is obtained by pinching a circle in a nearby regular fiber, called the *vanishing cycle*.

A Lefschetz fibration can be described combinatorially by means of their monodromy. For a Lefschetz fibration $\pi : E \rightarrow B$ with fibers diffeomorphic to a surface S , define the *monodromy representation* $\Psi : \pi_1(B - \text{critical values}) \rightarrow \text{Map}(S)$ as follows. Fix an identification ϕ of S with the fiber over a base point b in B . For

each loop $\gamma : S^1 \rightarrow B$ the bundle $\pi_\gamma : \gamma^*(E) \rightarrow S^1$ is canonically given by an element $f \in \text{Map}(S)$, since $\gamma^*(E)$ is diffeomorphic to $S \times [0, 1] / \sim$. Here \sim is given by $(x, 0) \sim (f(x), 1)$. Note that here we need a fixed identification ϕ of $\pi_\gamma^{-1}(0)$ and $\pi_\gamma^{-1}(1)$ with S . Thus we obtain an element $\Psi(\gamma) \in \text{Map}(S)$.

Now we restrict to the case of Lefschetz fibrations over D^2 , $\pi : X \rightarrow D^2$. To describe the topology of the Lefschetz fibration we recall some notions from topology. We refer the reader to [37] for details.

Definition 7.1.8 (*k*-handle). *A n -dimensional k -handle, $0 \leq k \leq n$, is topologically homeomorphic to $D^k \times D^{n-k}$. A k -handle is attached to the boundary of n -manifold M^n , by an embedding $f : \partial D^k \times D^{n-k} \rightarrow \partial M$. The new manifold will be written as $M \cup_f h$. The integer k is called the index of the handle h . We call $D^k \times 0$ the core of the handle h , $0 \times D^{n-k}$ the cocore of h , f the attaching map, $\partial D^k \times D^{n-k}$ the attaching region and $0 \times \partial D^{n-k}$ the belt sphere.*

First note that for any Lefschetz fibration $\pi : X \rightarrow D^2$, the function $|\pi|^2 : X \rightarrow [0, 1]$ is a Morse function away from 0, with the same critical points as π . This gives us a way of building X as a handlebody. First we start out by showing that a Lefschetz critical point corresponds to a 4-dimensional 2 handle attached along a vanishing cycle. Recall that near a critical point we can write π as $\pi(z_1, z_2) = z_1 z_2$. It can be easily checked that $z_1 z_2$, is equivalent by a conformal change of co-ordinates to $z_1^2 + z_2^2$. So we can assume that near critical point we have a local chart such that $\pi(z_1, z_2) = z_1^2 + z_2^2$. So a regular fiber is given by $z_1^2 + z_2^2 = t$. We can assume that $t > 0$ after multiplying π by a unit complex number. The intersection of the real part of \mathbb{C}^2 with co-ordinates (x_1, x_2, y_1, y_2) , with the fiber gives $x_1^2 + x_2^2 = t$ in \mathbb{R}^2 . This circle bounds a disk D_t in \mathbb{R}^2 . This is called the *Lefschetz thimble*. As $t \rightarrow 0$, D_t shrinks to a point in \mathbb{R}^2 . Thus $\partial D_t = F_t \cap \mathbb{R}^2$ is the vanishing cycle of the critical point. So we see the singular fiber F_0 is created from F_t by collapse of vanishing cycle. Thus a regular neighbourhood νF_0 is obtained from νF_t by attaching a regular

neighbourhood of D_t . A regular neighbourhood of D_t is a 2 handle h . It is easy to see from this discussion that the attaching circle is the vanishing cycle. Now we describe the framing of h . Suppose $\partial\nu F_t$ contains a disk D_s for some $s < t$. The core of the 2-handle h is D_s and attaching circle is the vanishing cycle $\partial D_s \subset \partial\nu F_t$. At a point $(\sqrt{s}\cos(\theta), \sqrt{s}\sin(\theta), 0, 0) \in \partial D_s$, vector $w = (-\sin(\theta), \cos(\theta), 0, 0)$ is tangent to ∂D_s . Note that $v(\theta) = (0, 0, -\sin(\theta), \cos(\theta))$ on ∂D_s is also tangent to F_s since F_s is a complex submanifold. Note that v and w are orthogonal. So v provides a normal to ∂D_s in F_s . This framing has to be compared with the one we get by considering a parallel copy of the attaching circle in the 2-handle. Note that in the tangent space of 2-handle we can choose the corresponding vector field to be $(0, 0, 0, i)$. This shows that the two choices differ by 1. By taking orientation into account one can conclude that the framing has to be -1 .

We now describe the monodromy around each critical value for a general Lefschetz fibration $\pi : X \rightarrow S$. Let D be a disk contained in S . As observed before if D does not contain any critical values, then $\pi|_D$ is trivial. Now assume that D contains a unique critical value. From the above description of attaching map it is easy to verify that the monodromy around the critical value is a positive Dehn twist about the vanishing cycle.

Now we piece together all this data. Let $\pi : X \rightarrow D$ be a Lefschetz fibration over a disk with n critical points lying in distinct fibers $F_i = \pi^{-1}(p_i)$, $i = 1, \dots, n$. Choose a regular fiber $F_0 = \pi^{-1}(p_0)$ and embedded arcs $a_1, \dots, a_n \subset D$, where a_i connects p_0 to p_i . The arcs a_i are disjoint except at p_0 . The arcs are cyclically ordered by travelling counterclockwise around p_0 . Note that $\pi^{-1}(a_i)$ determines a map gluing νF_i to νF_0 . Now the union is all of X except for a collar. So we can describe X as $D^2 \times F_0$ with n 2-handles h_1, \dots, h_n attached with the framing -1 to the vanishing cycle for F_i . In the same way the monodromy can be described by an ordered n -tuple (ϕ_1, \dots, ϕ_n) of right handed Dehn twists of F such that ϕ_i is monodromy around p_i . The total

monodromy is given by $\phi_n \circ \phi_{n-1} \circ \cdots \circ \phi_1$. The Lefschetz fibration $\pi : X \rightarrow D^2$ is completely determined by the collection (ϕ_1, \dots, ϕ_n) aside from cyclic permutation of the indices and conjugation of the all the elements ϕ_i by a fixed element of $Map(F)$ and different choices of the arcs a_i . Given two choices of $\{a_i\}$, it is possible to go between them by a sequence of moves, each of which changes the pair (ϕ_i, ϕ_{i+1}) to $(\phi_{i+1}, \phi_{i+1}^{-1} \circ \phi_i \circ \phi_{i+1}^1)$. This move is called the *Hurewitz move*.

Now if the base surface S is a sphere S^2 , then by assuming that all the critical values are contained in upper hemisphere, we see that the total monodromy over the upper hemisphere has to be trivial, as we can split up the original Lefschetz fibration as fibration over the upper hemisphere and a Lefschetz fibration over lower hemisphere. The fibration over lower hemisphere is trivial. So we see that the total monodromy of the Lefschetz fibration over upper hemisphere has to be identity to get a Lefschetz fibration over a sphere. We will not discuss Lefschetz fibrations over other surfaces here. But the discussion above essentially describes Lefschetz fibrations over arbitrary surfaces.

The theory of Lefschetz fibration ties up nicely with the symplectic geometry due to following result, whose forward implication was proved by Donaldson and the reverse implication is due to Gompf.

Theorem 7.1.9. *A closed 4-manifold X admits a symplectic structure if and only if it admits a Lefschetz fibration after finitely many blow-ups.*

We have not formally defined blow-ups. For a smooth, oriented 4 manifold X , the connect sum $X' = X \# \overline{CP^2}$ is called the *blow-up* of the manifold X . It is known that if X admits a symplectic structure then so does X' .

7.2 Symplectic Fillings

Before we actually begin our study of symplectic fillings, let us give some motivation. Recall, that any 3-manifold can be the boundary of a 4-manifold. To consider

analogous statements for contact 3 manifolds we have to restrict to the class of “appropriate” symplectic 4 manifolds which we will define shortly. In this context we have the following theorem due to Eliashberg and Gromov.

Theorem 7.2.1 (Eliashberg-Gromov). *Any weakly fillable manifold (M, ξ) is tight.*

This already shows that there are obstruction to having a 4-manifold bound a given contact 3-manifold in a symplectic way. Even if a contact 3 manifold bounds a symplectic 4-manifold, there is a sever restriction on which symplectic 4 manifolds it can bound. This is shown by following theorem of Gromov [39] and its strengthening due to Eliashberg [11].

Theorem 7.2.2. *The only symplectic filling of (S^3, ξ_{std}) is (B^4, ω_{std}) up to symplectomorphism and blow ups.*

This is very different from smooth case and is unexpected. To begin our study of symplectic fillings, we start by defining contact type hypersurfaces.

Definition 7.2.3. *A vector field v on a symplectic manifold (X, ω) is called Liouville vector field if $\mathcal{L}_v \omega = \omega$. A hypersurface $Y \subset X$ of codimension 1 is of contact type if there is a Liouville vector field, defined on a neighbourhood of Y that is transverse to Y .*

The Liouville vector field is also called a *symplectic dilation*. Note that Y being a hypersurface determines a line bundle $L_Y = TY^\perp$, here the orthogonal complement is the symplectic complement of TY in TM . This is a line bundle contained in TY . We give a characterization of contact type hypersurfaces due to Weinstein [76].

Lemma 7.2.4. *A submanifold $Y \subset X$ is contact type if and only if there is a 1-form α on Y such that $d\alpha = \omega|_Y$ and $\alpha|_{L_Y}$ is never zero.*

Proof. Suppose Y is a hypersurface of contact type and v is a symplectic dilation transverse to Y . Then $\alpha' = i_v \omega$ is a 1-form defined in a neighbourhood of Y . By

definition, $\omega = \mathcal{L}_v\omega = (di_v + i_v d)\omega = d\alpha'$. Thus the 1-form $\alpha = i^*\alpha'$ satisfies the first condition. For the second condition, suppose $H : M \rightarrow \mathbb{R}$ is a function that defines Y i.e. $Y = H^{-1}(c)$ for some regular value c of H . This allows us to define a unique vector field v_H such that $dH = i_{v_H}\omega$. One can check that the line bundle L_Y is spanned by v_H . Then $\alpha'(v_H) = (i_v\omega)(v_H) = \omega(v, v_H) = -dH(v) \neq 0$.

Suppose Y is a hypersurface and α is a 1-form on Y satisfying the given conditions. One can extend the 1-form α to a 1-form α' on a neighbourhood of Y so that $d\alpha' = \omega$. Since ω is nondegenerate, we get a vector field v so that $i_v\omega = \alpha'$. \square

It turns out that the symplectic structure is uniquely determined by, the Liouville vector field v and the contact structure $\xi = \ker(\alpha)$, in the tubular neighbourhood of the surface Y . It is relatively easy to check that this is symplectomorphic to the manifold $Y \times \mathbb{R}$ with the symplectic structure given by $\omega = d(e^t\alpha)$. The manifold $Y \times \mathbb{R}$ is called symplectisation of the contact manifold Y .

Definition 7.2.5 (ω -convexity). *We say a codimension 0 submanifold $U \subset X$ in (X, ω) is ω -convex, if ∂U is contact type and the Liouville vector field point out of ∂U .*

Definition 7.2.6 (Strong symplectic fillings). *A contact 3 manifold (M, ξ) is called strongly symplectically fillable if it is the ω -convex boundary of a symplectic 4-manifold (X, ω) .*

Examples of symplectic manifolds with ω -convex boundaries can be found easily. This is evident from following results. See [19] for proofs.

Theorem 7.2.7. *Let S be a Lagrangian submanifold in a symplectic manifold (X, ω) . Then S has a tubular neighbourhood with ω -convex boundary. Moreover, if S_i is Lagrangian submanifolds of (X, ω) , for $i = 1, \dots, n$ with each pair of S_i 's intersecting ω -transversely, then $\cup_{i=1}^n S_i$ has a neighbourhood with ω -convex boundary.*

Interestingly the case for symplectic submanifolds is very different compared to the Lagrangian case in the theorem above. For example consider, two symplectic 2 spheres in a symplectic manifold such that each has self intersection number -1 and a single transverse point of intersection between them. A neighbourhood N of these spheres has boundary $S^1 \times S^2$. After blowing down one of the -1 spheres we get $D^2 \times S^2$. If this boundary is convex we would get a strong symplectic filling of $S^1 \times S^2$ by $D^2 \times S^2$. By a theorem of Eliashberg [11], this is never the case.

There are stronger notions of fillability of a contact manifold (M, ξ) .

Definition 7.2.8 (Exact fillings). *A strong symplectic filling (X, ω) of a contact manifold (M, ξ) is called an exact filling if the Liouville vector field v is defined everywhere on the manifold X . Another equivalent way of saying this is that ω is an exact 2 form on the whole of X .*

In the following discussion we will only say convex boundary instead of ω -convex boundary. When the vector field v points into the manifold, we will call the boundary *concave*. The importance of symplectic convexity is due to the fact that it can be used in symplectic cut and paste operations.

Theorem 7.2.9 (Symplectic cut and paste). *Let $U_i \subset (X_i, \omega_i)$ be codimension 0 manifolds with ω_i -convex boundaries $(M_i, \xi_i) = \partial U_i$. If there is a contactomorphism $f : (M_1, \xi_1) \rightarrow (M_2, \xi_2)$ then the manifold $(X \setminus U_1) \cup_f U_2$ admits a symplectic structure.*

Proof. Let $\alpha_i = i_{v_i} \omega_i$ denote the contact forms on Y_i and suppose $f^* \alpha_1 = g \alpha_2$ where $g : M_1 \rightarrow \mathbb{R}$ is a nonzero. By rescaling α_2 we can assume that $0 < g < 1$. In the symplectization $M_1 \times \mathbb{R}$ of (M_1, ξ_1) , we have $Y_1 \cong M_1 \times \{1\}$ and $M_2 \cong \text{graph}(\ln(g))$. Each of these is a contact type hypersurface and has a neighbourhood N_i symplectomorphic to a neighbourhood of ∂U_i . We can arrange that the neighbourhoods N_i cobound a region T in the symplectization $M_1 \times \mathbb{R}$. Now we use the symplectomorphisms given above, to get a new manifold:

$$X = (X_1 \setminus U_1) \cup T \cup U_2.$$

It is obvious that this manifold has a symplectic form and is diffeomorphic to $(X_1 \setminus U_1) \cup U_2$. \square

One of the most interesting special cases of the symplectic cut and paste operation is gluing a Weinstein 2-handle. We give a proof of the fact that a 2 handle can be attached symplectically to a convex symplectic 4-manifold. This is originally due to Weinstein [77]. Let $\omega_{std} = dx_1 \wedge dy_1 + dx_2 \wedge dy_2$ denote the standard symplectic form on \mathbb{R}^4 . Let H denote the region defined by the inequalities

$$f = x_1^2 + x_2^2 - \frac{1}{2}(y_1^2 + y_2^2) \geq -1$$

and

$$g = x_1^2 + x_2^2 - \frac{\epsilon}{6}(y_1^2 + y_2^2) \leq \frac{\epsilon}{2}.$$

The gradient of f is $2x_1 \frac{\partial}{\partial x_1} - y_1 \frac{\partial}{\partial y_1} + 2x_2 \frac{\partial}{\partial x_2} - y_2 \frac{\partial}{\partial y_2}$. It is easy to check that $\mathcal{L}_v \omega = di_v \omega = \omega$. So $v = \nabla f$ is a Liouville vector field and is transverse to the hyperplane $f^{-1}(-1)$ since $\langle \nabla f, v \rangle = |v|^2 > 0$, ∇f points out of H . Similarly, it is a straightforward calculation to check that v is transverse to $g^{-1}(\frac{\epsilon}{2})$ and points into H . Hence v points out of H along $g^{-1}(\frac{\epsilon}{2})$ and points into H along $f^{-1}(-1)$. Note that the attaching circle

$$K_1 = \{x_1, x_2 = 0, y_1^2 + y_2^2 = 2\} \subset f^{-1}(-1) \cap \partial H$$

is a Legendrian knot. Indeed, at a point $(0, 0, y_1, y_2)$ it has a tangent vector $w = -y_2 \frac{\partial}{\partial y_1} + y_1 \frac{\partial}{\partial y_2}$. The contact form on the boundary is given by $\alpha = i_v \omega = 2x_2 dy_1 + y_1 dx_1 + 2x_2 dy_2 + y_2 dx_2$. So we see that $\alpha(w) = 0$. So we see that K_1 is a Legendrian knot. Similarly

$$K_2 = \{x_1^2 + x_2^2 = \frac{\epsilon}{2}, y_1 = y_2 = 0\} \subset g^{-1}(\frac{\epsilon}{2}) \cap \partial H$$

is a Legendrian knot.

Theorem 7.2.10 (Weinstein handle attachment). *Let (M, ξ) be a ω -convex boundary of (X, ω) and let $L \subset M$ is a Legendrian knot. Then we can attach 2-handle H to X along L so that the resulting manifold $X' = X \cup H$ is symplectic with a symplectic structure ω' and the boundary $\partial X'$ is ω' -convex.*

Proof. We know from above discussion that K is a Legendrian knot in ∂H . Since $L \subset M$ is also Legendrian both of them have contactomorphic neighbourhoods. This follows from Legendrian neighbourhood theorem. Now the theorem follows in a similar way to the symplectic cut and paste theorem. \square

This handle will be called Weinstein handle. Note that this handle attachment replaces the neighbourhood $N(L)$ of L in Y , with neighbourhood $g^{-1}(\frac{\epsilon}{2})$ of K in H . So Y' is obtained from Y by a surgery along a Legendrian knot. The following theorem tells us the exact surgery framing.

Theorem 7.2.11. *Attaching a Weinstein 2-handle to (X, ω) along a Legendrian knot L in its ω -convex boundary M gives a symplectic manifold (X', ω') whose boundary M' is ω' -convex and is obtained by performing a Legendrian surgery along L .*

Proof. The contact framing of L is a non zero section of $\xi|_L$ which is transverse to TL . The attaching circle K has tangent bundle TK spanned by $-y_2 \frac{\partial}{\partial y_1} + y_1 \frac{\partial}{\partial y_2}$. Since $\alpha = y_1 dx_1 + y_2 dx_2$ along K , the contact framing is easily seen to be $-y_2 \frac{\partial}{\partial x_1} + y_1 \frac{\partial}{\partial x_2}$.

The framing used to do surgery can be taken to be the constant vector field $\frac{\partial}{\partial x_1}$. It is easy to see that the the vector field $-y_2 \frac{\partial}{\partial x_1} + y_1 \frac{\partial}{\partial x_2}$ makes full positive twist with respect to $\frac{\partial}{\partial x_1}$, as we travel along K . So we see that the framing we get by pushing K off of itself in H is one less than the contact framing. The result follows. \square

This shows that Legendrian surgery preserves strong symplectic fillability. Now we discuss even stronger notion of fillability called Stein fillability. There are several equivalent ways of defining the Stein fillings of a contact manifold.

Definition 7.2.12 (Stein manifold). *A Stein manifold X is a complex manifold which admits proper holomorphic embedding into \mathbb{C}^n for some n . A (complex) two dimensional Stein manifold is called a Stein surface. Another characterization of Stein manifolds due to Grauert [38] is that, they are precisely the ones which admit an exhausting strictly plurisubharmonic function f . A strictly pluri-subharmonic function on (X, J) is a function $f : X \rightarrow \mathbb{R}$ for which $\omega = -d(df \circ J)$ is a symplectic form that defines a metric $g_f(v, w) = \omega(v, Jw)$ and for which the level set $f^{-1}(-\infty, c]$ are compact.*

So we know that a Stein manifold admits a symplectic structure given by ω in the above definition. We denote it by ω_f to explicitly show the dependence on the function f . Let ∇_f denote the gradient vector field for the function f . Then by definition of gradient vector field, $i_{\nabla_f} g_f = df$. So $i_{\nabla_f} \omega_f(\cdot, \cdot) = \omega_f(\nabla_f, \cdot) = -g_f(\nabla_f, J\cdot) = -J^* g_f(\nabla_f, \cdot) = -J^* df$. So we can compute $\mathcal{L}_{\nabla_f} \omega_f = di_{\nabla_f} \omega_f + i_{\nabla_f} d\omega_f = di_{\nabla_f} \omega_f = -dJ^* df = \omega_f$. So we see that gradient vector field of a plurisubharmonic function is a symplectic dilation. We also note here that the contact structure induced on a hypersurface $Y = f^{-1}(c)$ for some regular value c is contactomorphic to the one induced by complex tangencies i.e. $\xi = TY|_Y \cap J(TY)|_Y$.

Definition 7.2.13 (Stein fillings). *A complex two dimensional manifold (X, J) is called a Stein filling of a contact 3 manifold, (M, ξ) , if (X, J) is a Stein surface such that (M, ξ) is contactomorphic to ω_f -convex boundary $f^{-1}((-\infty, c])$ for some regular value c where f is the strictly plurisubharmonic function associated to the Stein manifold (X, J) . The manifold $f^{-1}((-\infty, c])$ is called a Stein domain with boundary M .*

Eliashberg [12], proved that Weinstein handle attachment can also be done in the category of Stein domains.

Theorem 7.2.14 (Stein 2-handle attachment). *If (X, J) is a Stein domain with*

boundary M , then the complex structure on X and the plurisubharmonic exhausting function $f : X \rightarrow \mathbb{R}$ can be extended across the handle h , so that $X' = X \cup h$ is a Stein manifold and $M' = \partial(X \cup h)$ is the level set of a regular value.

It follows that Legendrian surgery preserves Stein fillability. Using this Eliashberg gave a characterization of Stein manifolds [12, 36].

Theorem 7.2.15 (Stein characterization). *An oriented 4-manifold is a Stein manifold if and only if it has a handle decomposition with all handles of index less than or equal to 2 and each 2-handle is attached to a Legendrian knot L with the framing on L being the (-1) -framing with respect to the contact planes.*

The importance of Stein and strong symplectic fillings is given by the fact that they can be used in symplectic cut and paste as described above. Symplectic cut and paste is an important operation in constructing interesting symplectic manifolds. Apart from these there is an important type of filling of a contact manifold.

Definition 7.2.16. *A contact manifold (M, ξ) is called weakly symplectically fillable if there is a symplectic manifold (X, ω) such that $\partial X = M$ and $\omega|_{\xi} > 0$.*

The importance of definition of weak symplectic filling has origins in a theorem due to Eliashberg and Thurston [15], which states that any taut foliation on a 3-manifold M can be perturbed to be a contact structure that is weakly fillable and Theorem 7.2.1.

With all these different notions of symplectic fillability of contact manifolds we have following implications which are obvious from the definitions and above discussion.

$$(Stein\ filling) \Rightarrow (Strong\ filling) \Rightarrow (Weak\ filling) \Rightarrow (Tight)$$

Let (Stein fillable), (Exactly fillable), (Strongly fillable), (Weakly fillable) and (Tight Structures) denote the sets of contact manifolds that are Stein fillable, exactly fillable, strongly fillable, weakly fillable and tight, respectively. In light of

the above implications we would like to know if the inclusions (*Stein fillable*) \subset (*Exactly fillable*) \subset (*Strongly fillable*) \subset (*Weakly fillable*) \subset (*Tight Structures*) are strict? Note that we have used the Eliashberg-Gromov theorem stated at the start of this section to conclude that fillable implies tight. We now proceed to state examples which show that each of these inclusions is strict.

Tight not Weakly fillable contact structure: Examples of tight but now fillable contact structures were first given by Etnyre and Honda [25]. They prove that the Seifert fibered spaces $S(-\frac{1}{2}, \frac{1}{4}, \frac{1}{4})$ fibered over S^2 carries a tight but not fillable contact structure. The proof relies on a result due to Lisca [49] that $S(-\frac{1}{2}, \frac{1}{3}, \frac{1}{4})$ does not carry any symplectically fillable contact structure and that symplectic fillability is preserved under Legendrian surgery. They prove that the Seifert fibered space $S(-\frac{1}{2}, \frac{1}{3}, \frac{1}{4})$ is obtained from $S(-\frac{1}{2}, \frac{1}{4}, \frac{1}{4})$ by a Legendrian surgery, thus proving the existence of non fillable contact structure. We remark that there are plethora of examples of tight, but not fillable contact structure now with the advent of new techniques [58, 79, 62, 4].

Weak but not strongly fillable contact structures: First examples of weakly but not strongly fillable tight contact structures were given by Eliashberg [16]. Recall that we have a family of contact structures on T^3 given by $\xi_n = \ker(\alpha_n) = \ker(\cos(n\theta)dx + \sin(n\theta)dy)$. Here we (x, y, θ) are co-ordinates on T^3 . All these contact structures are tight as they have universal covering $(\mathbb{R}^3, \xi_{std})$. We can prove easily that these are all weakly fillable. The form $\alpha_n^\epsilon = (1 - \epsilon)d\theta + \epsilon\alpha_n$ is a contact form on T^3 . By Gray's theorem all of them are isotopic to α_n for each $\epsilon > 0$. Let $X = T^2 \times D^2$ be a symplectic manifold with the symplectic structure given by the product symplectic structure coming from T^2 and D^2 . Note that the tori $T^2 \times \{p\}$, $p \in \partial D^2$ contained in the boundary 3-torus $T^2 \times \partial D^2$ are symplectic and are given by $d\theta = 0$. These tori satisfy $\omega|_{T^2 \times \{p\}} > 0$. Now symplectic being an open condition, ω does not vanish on $\ker(\alpha_n^\epsilon)$ for small enough ϵ . So we get that every α_n is weakly

symplectically fillable.

Eliashberg [16] proves that the contact structures ξ_n are not strongly fillable for $n > 1$. We present the argument here. Let $T = \{|z_1| = 1, |z_2| = 1\} \subset \mathbb{C}^2$. This torus is easily seen to be Lagrangian with the standard symplectic structure on \mathbb{C}^2 . We claim that a small neighbourhood N of T has convex boundary $\partial N = T^3$. To see this, one notes that $T^2 \times D^2$ is a unit cosphere bundle of T^2 . It is easy to check that the radial vector field in the cotangent bundle is the Liouville vector field for this symplectic manifold and so induces a contact structure ξ_1 on ∂N . By the Lagrangian neighbourhood theorem, we know that there is a neighbourhood of any Lagrangian L that is symplectomorphic to a unit bundle of L in T^*L . The contact structure $\xi_1 = \ker(\alpha_1)$, on ∂N is the standard contact structure given by complex tangencies and the contact structure is contactomorphic to ξ_1 . Let $Y = \mathbb{C}^2 \setminus \text{int}(N)$. We endow both Y and N with symplectic restrictions of the standard symplectic structure ω . The torus T^3 is the symplectically concave boundary of Y and convex boundary of N . For any n there is a n -sheeted cyclic cover $q_n : Y_n \rightarrow Y$, such that its restriction to the boundary coincides with the covering $p_n : T^3 \rightarrow T^3$ and the contact structure on Y_n is α_n . Here the covering map on the boundary is such that the S^1 factor given by θ is covered n times. The noncompact manifold $(Y_n, \omega_n = q_n^*(\omega))$ has n ends, and each of them is symplectomorphic to $(\mathbb{R}^4, \omega_{std})$ at infinity. It has concave boundary (T^3, ξ_n) . If (T^3, ξ_n) is strongly symplectically fillable we obtain, by symplectic cut and paste, a manifold which has n ends all of them symplectomorphic to $(\mathbb{R}^n, \omega_{std})$. This is not possible for $n > 1$, due to a theorem McDuff [60], which states that if (S^3, ξ_{std}) is a convex boundary component of any symplectic manifold (S, Ω) with convex boundary, then the boundary is connected. Hence, we know that $n = 1$ and for $n > 1$ the contact structures are not strongly fillable.

These examples were generalized by Ding and Geiges [8] to some torus bundles over the circle. On a torus bundle T_A over a circle with monodromy $A \in SL_2(\mathbb{Z}), \text{tr}(A) \neq$

-2 , they construct infinitely many fillable contact structures. They also prove that only finitely many of them are strongly fillable. This is done by finding a Legendrian surgery on a knot in T_A which gives T^3 with the one of the contact structures that Eliashberg shows are not strongly fillable.

Strongly fillable but not Stein fillable contact structure: These examples were first found by Ghiggini [32]. The manifolds are obtained by $\frac{1}{(n+1)}$ surgery on the trefoil. Ghiggini proves that a particular contact structure on these manifolds is not Stein fillable for $n \geq 2$ and even, but is strongly fillable. The manifolds can be understood as 0 surgery on the trefoil and a $-(n+1)$ surgery on its meridian. The 3-manifold obtained by 0-surgery along the trefoil is a torus bundle over S^1 . The monodromy of this torus bundle is well understood and is the ones used by Ding-Geiges in their examples mentioned above. These contact structures are all weakly fillable in a similar way as proved for T^3 above. Now the manifold of interest is obtained as a $(n+1)$ surgery along meridian of this knot. Ghiggini proves that this meridian can be realized as a Legendrian knot with twisting $-n$ and hence the manifold is obtained as a Legendrian surgery, in the 0 surgered manifold. The resulting manifold is an integral homology sphere as can be verified by simple intersection matrix computation. It is weakly fillable as Legendrian surgery preserves weak fillability. On homology spheres Eliashberg [14] proves that any weak symplectic filling can be perturbed to a strong symplectic filling. Therefore, we have a strongly fillable contact manifold. To prove that this is not Stein fillable Ghiggini uses Heegaard-Floer homology. See [32].

Exactly fillable but not strongly fillable: These examples were found by Bowden [7] and build upon the examples of Ghiggini. Take a symplectic manifold which has two convex boundary components, one of which is the example given by Ghiggini. Such examples exist by a construction of McDuff [60] and Geiges [30]. Now one attaches a Weinstein 1 handle along the boundary components. This gives a symplectic manifold with connected convex boundary and the boundary is the

connect sum of the original boundary manifolds. If it were Stein fillable, a theorem of Eliashberg [11] would imply each of the individual contact structure was Stein fillable. A contradiction. Now one proves that the new manifold obtained is exactly fillable by looking at long exact sequence in homology.

In the light of all these results it is important to ask when are any of these notions equivalent? It follows from a result of Eliashberg [14], that one can perturb any weak symplectic filling of a rational homology sphere to a strong symplectic filling. Ghiggini's examples mentioned above show that on rational homology spheres, one cannot perturb any strong filling to a Stein filling. Wendl's theorem [78], on which a large portion of this thesis is based says that this is possible in the case of contact manifolds supported by planar open books. We state the theorem now.

Theorem 7.2.17 (Wendl [78]). *If (M, ξ) is a manifold supported by a planar open book decomposition, then any strong symplectic filling of (M, ξ) , is a blow up of a Stein filling.*

A generalization of this theorem to weak fillings was done by Wendl and Niederkruger [62]

Theorem 7.2.18 (Wendl-Niederkruger). *If (M, ξ) is a contact manifold supported by planar open book, then every weak filling of (M, ξ) can be deformed to a blow up of a Stein filling.*

The main goal of this thesis is to understand what can we say about the set of Stein fillings of a given contact manifold? In particular, we would like to classify the Stein fillings up to either symplectomorphism or diffeomorphism.

7.2.1 Lefschetz fibrations and Stein fillings

Let $\pi : X \rightarrow D^2$ be a Lefschetz fibration with fiber a surface S . Recall from topological construction of Lefschetz fibrations that we construct the Lefschetz fibration by attaching 2-handles to $S \times D^2$, along knots given by the vanishing cycles with framing

–1. Now it follows from theorem of Eliashberg and its extension by Gompf that this manifold is Stein. Note that the boundary of a Lefschetz fibration is a contact manifold with open book decomposition given by (S, ϕ) where ϕ is the total monodromy of the Lefschetz fibration π . One would like to know whether the converse hold, i.e, can every Stein surface be given the structure of a Lefschetz fibration? This is a theorem of Akbulut-Ozbagci [1] and independently due to Loi-Piergallini [54]

Theorem 7.2.19. *If (X, J) is a Stein domain then X admits a Lefschetz fibration such that the vanishing cycles are homologically essential.*

We will not give a proof of this theorem. We refer the reader to the papers mentioned above for the proofs. Now if (X, J) is a Stein domain, then ∂X has a natural contact structure as a boundary of a Stein domain. Also since, this Stein domain admits a Lefschetz fibration structure, the boundary gets an induced open book decomposition. It is not clear whether this open book decomposition is compatible with the contact structure induced on the boundary ∂X . It turns out this is the case, due to a theorem of Plamenevskaya [64]

This gives a characterization of Stein fillings in terms of supporting open book decomposition.

Theorem 7.2.20 (Giroux). *A contact manifold (M, ξ) is Stein fillable if and only if there is an open book decomposition for (M, ξ) whose monodromy is written a product of right-handed Dehn twists.*

Proof. Suppose that $\phi = \tau_{a_1} \dots \tau_{a_n}$ is a positive factorization about homologically non trivial curves in a surface $S_{g,n}$. Then the positive Lefschetz fibration with monodromy ϕ given by a positive factorization, gives a Stein filling of (M, ξ) . Given (M, ξ) , any Stein filling of (M, ξ) can be constructed as a Lefschetz fibration $\pi' : X' \rightarrow D^2$ and thus induces an open book compatible with the contact structure (M, ξ) . \square

Note that the proof says that any Stein fillings of (M, ξ) comes from a positive factorization of the monodromy of some open book decomposition supporting ξ . So to find all Stein fillings of a given contact structure we must find all positive factorizations of the positive monodromies for every possible compatible open book. We remark here that, there are examples of open book decompositions supporting a Stein fillable contact structure whose monodromy cannot be factored as a product of positive Dehn twists. These examples were first found by Baker, Etnyre, and Van Horn-Morris [3] and independently by Wand [74].

In the case of planar open books, we have the following result of Wendl, which states that any Stein filling of (M, ξ) extends to a Lefschetz fibration with the same page.

Theorem 7.2.21 (Wendl). *Suppose (X, ω) is a strong symplectic filling of a planar contact manifold (M, ξ) and (B, π) is a planar open book decomposition supporting ξ . Then there is an enlarged filling (X', ω') obtained by attaching a trivial symplectic cobordism to X , such that X' admits symplectic Lefschetz fibration $\Pi : X' \rightarrow D$ for which $\Pi|_{\partial X' \setminus B} = \pi$. Moreover, $\Pi : X' \rightarrow D$ is allowable if X is minimal.*

A Lefschetz fibration is called *allowable* if the vanishing cycles are homologically essential curves in the fibers. As a corollary we get the following result.

Corollary 7.2.22. *If (M, ξ) is a contact manifold supported by a planar open book (Σ, ϕ) , then it is strongly fillable (thus Stein fillable) if and only if ϕ is isotopic to a product of positive Dehn twists.*

Proofs of these theorems require the machinery of pseudo-holomorphic curves and will take us too far away from the main topic of this thesis. But the important implication for us is that to classify Stein fillings of a contact manifold supported by a planar open book, we need to find all positive factorization of a given monodromy up to a global diffeomorphism of the page and Hurewicz moves. This is our strategy to

understand and classify Stein fillings of some planar contact manifolds. This strategy was used by Plamenevskaya and Van Horn-Morris [66] to classify Stein fillings of some contact structures on lens spaces.

7.3 *Classification of Stein fillings:*

In this section we describe all the known results about the classification of Stein fillings for any contact manifold. We have a theorem of Gromov.

Theorem 7.3.1 (Gromov). *Every Stein filling of (S^3, ξ_{std}) is diffeomorphic to 4-ball.*

Eliashberg [11] extended this to show that the filling is symplectomorphic to the symplectic ball in \mathbb{C}^2 .

Following this McDuff [59] proved a classification of Stein fillings of the universally tight contact structure on the lens spaces $L(p, 1)$. We remark here that by a result of Honda [42] and Giroux [35] any lens space has exactly 1 universally tight contact structure up to contactomorphism. We will denote this structure by ξ_{std} .

Theorem 7.3.2 (McDuff). *Any lens space $(L(p, 1), \xi_{std})$ has a unique Stein filling except when $p \neq 4$ up to diffeomorphism. When $p = 4$ it has exactly 2 Stein fillings up to diffeomorphism.*

This theorem of McDuff was improved to symplectic deformation equivalence by Hinds [41]. Classification, up to diffeomorphism, of Stein fillings of any lens space $(L(p, q), \xi_{std})$ was given by Lisca [50].

Ohta and Ono classified Stein fillings of certain links of isolated singularities. By a link of isolated singularity we mean intersection of a hypersurface given by non constant polynomial $f(z_1, z_2, z_3) = 0$ with a sphere S_ϵ^5 of a small radius ϵ centered around a point which is an isolated critical point of f . We denote this by L_ϵ . If the sphere is not centered around a critical point the intersection is diffeomorphic to 3 sphere. A link of isolated singularity L_ϵ carries a natural contact structure given by complex tangencies.

A simple singularity is an isolated singularity of one of the following polynomial: $x^{n+1} + yz$, $x^2y + y^{n-1} + z^2$, $x^4 + y^3 + z^2$, $x^3y + y^3 + z^2$, $x^3y + y^3 + z^2$, $x^5 + y^3 + z^2$. A minimal symplectic filling is a filling which is not a blow up of another filling. Ohta and Ono prove the following theorem [63].

Theorem 7.3.3 (Ohta-Ono). *Let X be any minimal symplectic filling of a link of simple singularity. Then the diffeomorphism type of X is unique. Moreover, the symplectic deformation type of X is unique.*

Stipsicz [68] classified Stein fillings of T^3 with the uniquely Stein fillable contact structure. He proved that the Stein filling is homeomorphic to $T^2 \times D^2$. Later Wendl [78] proved that up to symplectomorphism $T^2 \times D^2$ is a unique Stein filling of T^3 .

After this using Wendl's result on planar open books, Plamenevskaya and Jeremy Van Horn-Morris [66] classified Stein fillings of virtually overtwisted lens spaces $L(p, 1)$.

Theorem 7.3.4 (Plamenevskaya-Van Horn-Morris). *Let ξ denote a virtually overtwisted contact structure on the lens space $L(p, 1)$, then $(L(p, 1), \xi)$ has a unique Stein filling up to symplectic deformation.*

We remark here that there are examples of manifolds with infinitely many Stein fillings. See for example [2].

CHAPTER VIII

GEOGRAPHY OF STEIN MANIFOLDS AND CLASSIFICATION FOR LENS SPACES

In this section we prove theorems about the geography problem for Stein fillings of contact structures supported by planar open books. In addition, we also classify Stein fillings of some lens spaces. We start out by characterizing lantern relation in the mapping class group.

8.1 Characterization of lantern type relations.

The aim of this section is to give a characterization of the lantern relation. Along with the combinatorial arguments in Section 8.2 this gives us the ingredients required for the proofs of our theorems on the classification of symplectic fillings of lens spaces and the geography.

We will denote the geometric intersection number of curves and arcs by i . For this to be well-defined we assume all curves are isotoped to have minimal intersections.

Recall the classical lantern relation which states that $\tau_{b_1}\tau_{b_2}\tau_{b_3}\tau_{b_4} = \tau_\alpha\tau_\beta\tau_\gamma$. Here α, β, γ are curves as shown in Figure 9 and b_1, \dots, b_4 denote the curves isotopic to the boundary component as shown.

Lemma 8.1.1. *Let $\alpha', \beta' \in \mathbb{D}_3$ be curves that enclose the same set of boundary components as α, β respectively and satisfy $\tau_\alpha\tau_\beta = \tau_{\alpha'}\tau_{\beta'}$. Then there is $N \in \mathbb{Z}$ such that $\alpha' = \tau_\gamma^N(\alpha)$ and $\beta' = \tau_\gamma^N(\beta)$.*

Proof. Observe that $\tau_\alpha\tau_\beta = \tau_{\alpha'}\tau_{\beta'} = \tau_{b_1}\tau_{b_2}\tau_{b_3}\tau_{b_4}\tau_\gamma^{-1}$.

We will use the following characterization of multitwists due to Margalit [55] and independently due to Hamidi-Tehrani [40]. By a multitwist we mean product of Dehn

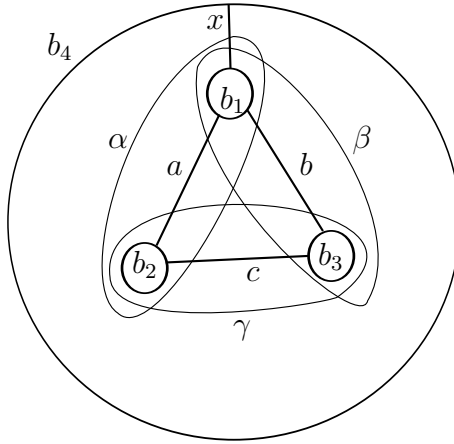

Figure 9: Classical Lantern relation.

twists about disjoint curves.

Proposition 8.1.2. *Let S be any surface and let α_1 and α_2 be curves in S that intersect minimally and non trivially. If $\tau_{\alpha_1}\tau_{\alpha_2} = M$, where M is a multitwist be a non-trivial relation in $\text{Map}(S)$, then the given relation is a lantern relation, that is, a regular neighbourhood R of $\alpha_1 \cup \alpha_2$ is a sphere with 4 open disks removed from the interior, and $M = \tau_{b_1}\tau_{b_2}\tau_{b_3}\tau_{b_4}\tau_{\alpha_3}^{-1}$. Here b_1, \dots, b_4 are curves isotopic to the boundary components of R and α_3 is a (non-unique) curve on R with geometric intersection number 2 with both α_1 and α_2 .*

Hence we know that $i(\alpha', \beta') = 2$. Similarly we get the following relations between intersection numbers $i(\alpha', \gamma) = i(\gamma, \beta') = 2$.

Since curves α and α' are homologous, there exists a diffeomorphism ϕ_1 which takes the curve α to α' . Similarly, there exists a diffeomorphism ϕ_2 which takes the curve β to β' . We claim that after isotopy the support of each of ϕ_1 and ϕ_2 is contained in the subsurface bounded by the curve γ . If ϕ_i is not a diffeomorphism supported in the subsurface bounded by γ , then we will show that each of the curves $\alpha' = \phi_1(\alpha)$ and $\beta' = \phi_2(\beta)$ must intersect curve γ at least six times contradicting the computation of intersection numbers above. One way to see this is by thinking of the

curves enclosing two different boundary components as represented by an arc joining the two boundary components. We can impose the condition that these arcs minimize the intersections with the boundary parallel curves corresponding to the boundary components they connect. We have shown the arcs representing the curves α, β , and γ in the Figure 9 and are denoted by a, b , and c , respectively. In this case, arcs a and b do not intersect the arc c . Now if ϕ_1 were a diffeomorphism not supported in the subsurface bounded by the curve γ , then $\phi_1(a)$ will intersect the arc x shown in Figure 9 non-trivially. Otherwise we could find a diffeomorphism ϕ'_1 whose support is contained in the subsurface bounded by the curve γ such that $\phi'_1(a)$ is isotopic to $\phi_1(a)$. Since $\phi_1(a)$ intersects x nontrivially, it also intersects the arc c non-trivially. If not then, one can isotope the arc $\phi_1(a)$ to have no intersection with arc x . Since $\phi_1(a)$ represented the curve α' this implies that the $i(\alpha', \gamma) \geq 6$.

Since any diffeomorphism which is supported in subsurface bounded by the curve γ is written as a product of Dehn twists given by $\tau_\gamma, \tau_{b_2}, \tau_{b_3}$, we get that $\phi_1 = \tau_\gamma^{N_1}$ and $\phi_2 = \tau_\gamma^{N_2}$. Here we have neglected the boundary Dehn twists τ_{b_2} and τ_{b_3} as they act trivially on curves α and β .

Now to prove the lemma we need to show that $N_1 = N_2$. Towards that end we recall following criterion on intersection numbers (see [26]).

Proposition 8.1.3. *Let A, B, C be any simple closed curves in a surface S and let $n \in \mathbb{Z}$. Then following holds,*

$$|n|i(A, B)i(A, C) - i(\tau_A^n(C), B) \leq i(B, C)$$

We apply this proposition with curves $A = \gamma, B = \beta, C = \alpha$. Let us assume that $N_1 > N_2$.

Note that $2 = i(\alpha', \beta') = i(\tau_\gamma^{N_1}(\alpha), \tau_\gamma^{N_2}(\beta)) = i(\tau_\gamma^{N_1 - N_2}(\alpha), \beta)$. Applying the proposition we get,

$$|N_1 - N_2| i(\gamma, \beta) i(\gamma, \alpha) - i(\tau_\gamma^{N_1 - N_2}(\alpha), \beta) \leq i(\beta, \alpha) = 2.$$

So we see that,

$$4|N_1 - N_2| - 2 = |N_1 - N_2| i(\gamma, \beta) i(\gamma, \alpha) - i(\beta, \alpha) \leq i(\tau_\gamma^{N_1 - N_2}(\alpha), \beta).$$

This gives a contradiction unless $|N_1 - N_2| = 0$ or 1 . Now we are only left to prove that the case $N_1 - N_2 = 1$ cannot happen. First we prove this when $N_1 = 1$ and $N_2 = 0$. This implies that $\beta' \cong \beta$ and $\alpha' \cong \tau_\gamma(\alpha)$. In particular, $\alpha' \not\cong \alpha$. From the hypothesis we have, $\tau_\alpha \tau_\beta = \tau_{\alpha'} \tau_\beta$ and hence $\tau_\alpha = \tau_{\alpha'}$. This in turn implies that $\alpha' \cong \alpha$, which is a contradiction.

Now let us assume that $N_1 = N_2 + 1$ and $N_2 \neq 0$. From the hypothesis $\tau_\alpha \tau_\beta = \tau_{\tau_\gamma^{(N_2+1)}(\alpha)} \tau_{\tau_\gamma^{N_2}(\beta)} = \tau_{b_1} \tau_{b_2} \tau_{b_3} \tau_{b_4} \tau_\gamma^{-1}$. Conjugating by $\tau_\gamma^{-N_2}$ on both the sides we see that $\tau_{\tau_\gamma(\alpha)} \tau_\beta = \tau_{b_1} \tau_{b_2} \tau_{b_3} \tau_{b_4} \tau_\gamma^{-1} = \tau_\alpha \tau_\beta$. Hence we have reduced the problem to the case when $N_1 = 1$ and $N_2 = 0$, in which case we already have proved the contradiction. So we get that $N_1 = N_2$. □

Now we prove the uniqueness of curves giving a lantern relation in the following lemma.

Lemma 8.1.4. *Let α, β, γ be curves as shown in Figure 9 and α', β', γ' be curves which enclose the same set of boundary components as α, β, γ , respectively. In addition, suppose that $\tau_\alpha \tau_\beta \tau_\gamma = \tau_{\alpha'} \tau_{\beta'} \tau_{\gamma'}$. Then there exists a diffeomorphism ψ of \mathbb{D}_3 such that $\gamma' \cong \psi(\gamma)$, $\alpha' \cong \psi(\alpha)$, and $\beta' \cong \psi(\beta)$.*

Proof. Since γ' and γ enclose the same set of boundary components, there exists a diffeomorphism λ taking γ' to γ . Conjugating by λ still gives a factorization of $\tau_{\alpha'} \tau_{\beta'} \tau_\gamma = \tau_\alpha \tau_\beta \tau_\gamma$ as $\tau_{b_1} \tau_{b_2} \tau_{b_3} \tau_{b_4}$ commutes with every diffeomorphism. Here, $\alpha'' = \lambda(\alpha)$ and $\beta'' = \lambda(\beta)$. Now we can apply Lemma 8.1.1 above to conclude that $\alpha'' \cong$

$\tau_\gamma^N(\alpha), \beta'' \cong \tau_\gamma^N(\beta)$. Hence, if we let $\psi = \tau_\gamma^N \lambda$, we get that $\alpha' = \psi(\alpha), \beta' = \psi(\beta), \gamma' = \psi(\gamma)$. This proves the lemma. □

8.2 Combinatorial arguments

In this section we give the combinatorial arguments needed in proofs of our results. Given a diffeomorphism $\Phi = \tau_{\alpha_1} \tau_{\alpha_2} \dots \tau_{\alpha_m}$ of a surface \mathbb{D}_n , written as a product of Dehn twists about curves $\alpha_1, \alpha_2, \dots, \alpha_m$. and another factorization of $\Phi = \tau_{\gamma_1} \tau_{\gamma_2} \dots \tau_{\gamma_k}$ we try to pin down the number of Dehn twists τ_{γ_i} and the boundary components, the curves $\gamma_1, \gamma_2, \dots, \gamma_k$ can enclose.

Before proceeding further we define homomorphisms from $Map(\mathbb{D}_n, \partial\mathbb{D}_n)$ to \mathbb{Z} , which define multiplicities associated to Dehn twists. Let $\Phi \in Map(\mathbb{D}_n, \partial\mathbb{D}_n)$ be a diffeomorphism. Let b_i and b_j be any boundary components of \mathbb{D}_n .

Definition 8.2.1 (Joint Multiplicity). *Capping off all the boundary components of \mathbb{D}_n except b_i and b_j and the outer boundary with disks and capping off boundary components b_i and b_j with disks we obtain a map to $\mathbb{Z} \subset Map(\mathbb{D}_2, \partial\mathbb{D}_2) \cong \mathbb{Z}^3$, which just counts the number of Dehn twists about the curve parallel to the outer boundary. We call this the joint multiplicity of boundary components b_i and b_j and denote it by $M_{ij}(\Phi)$.*

Definition 8.2.2 (Mutiplicity). *Cap off all the boundary components except b_i and the outer boundary. This induces a map from $Map(\mathbb{D}_n, \partial\mathbb{D}_n)$ to $Map(\mathbb{D}_1, \partial\mathbb{D}_1) \cong \mathbb{Z}$ and the map counts the Dehn twists about the boundary parallel curve. We call this the multiplicity of boundary component b_i . Denote it by $M_i(\Phi)$.*

Remark 8.2.3. *These homomorphisms were also defined and used in the paper by the author in [44]. Our definition of multiplicity differs slightly from the one defined in [66]. The multiplicity (denoted $m_i(\Phi)$) defined there is $M_i(\Phi) - \sum M_{ij}(\Phi)$. It is also clear that these are invariants of any factorization of Φ .*

Lemma 8.2.4. *Let $\Phi = \tau_{b_1}\tau_{b_2}\dots\tau_{b_{n+1}}$, where the curve b_i is parallel to the i^{th} boundary component, be an element of $\text{Map}(\mathbb{D}_n, \partial\mathbb{D}_n)$. Let $\Phi' = \tau_{\alpha_1}\tau_{\alpha_2}\dots\tau_{\alpha_m}$ be any other positive factorization of Φ . Then:*

1. *If $n \leq 2$ or $n \geq 4$, then $m = n + 1$ and each of the curves α_i is a boundary parallel curve b_j for some j .*
2. *If $n = 3$, then either Φ' is Hurewitz equivalent to $\tau_{b_1}\tau_{b_2}\dots\tau_{b_{n+1}}$ or Hurewitz equivalent to $\tau_{\alpha_1}\tau_{\alpha_2}\tau_{\alpha_3}$, where α_1 encloses boundary components b_1 and b_2 , α_2 encloses boundary components b_1 and b_3 and α_3 encloses boundary components b_2 and b_3 .*

Proof. Observe that $M_{ij}(\Phi) = 1$ for all i, j and $M_i(\Phi) = 2$ for all $1 \leq i \leq n$.

Let l_i be the number of curves that enclose boundary component b_i and at least one more boundary component in the factorization Φ' of Φ . Also let $n_j, 1 \leq j \leq l_i$ denote the total number of boundary components enclosed by each of these l_i curves.

It follows from the definition of M_i and the fact that $M_i(\Phi) = 2$ that for each $i, 1 \leq l_i \leq 2$, in any positive factorization of Φ . We will prove that if $l_i = 1$ for some i , then $l_i = 1$ for all i . To prove this, without loss of generality we can assume that $l_1 = 1$. This means that there exactly one curve enclosing the boundary component b_1 and at least one more boundary component. Let us call the curve α . Since $M_{1i}(\Phi) = 1$ for all i , we conclude that α encloses all the boundary components b_1, b_2, \dots, b_n . Now by the fact that $M_{ij}(\Phi) = M_{ij}(\Phi') = 1$ for all i, j , we see that α is the unique curve enclosing all the boundary components. In this case all joint multiplicities of all the boundary components are satisfied. Hence, in the factorization of Φ all other Dehn twists are about boundary parallel curves. Hence we get that, $l_i = 1$ for all i . Since all the curves involved are boundary parallel, this factorization is the same as the original.

Now let us assume that $l_i = 2$ for all i . This means there are exactly two curves, α_1

and α_2 , enclosing the boundary component b_1 . If $i \neq 1$ and the boundary component b_i is enclosed by α_1 , then the boundary component b_i cannot be enclosed by the curve α_2 . This is because $M_{1i}(\Phi') = 1$. Hence we see that curves α_1 and α_2 have only the boundary component b_1 in common. Let us assume that curve α_1 encloses k boundary components ($k < n$). Without loss of generality, we can assume that α_1 encloses boundary components b_1, b_2, \dots, b_k and α_2 encloses boundary components b_1, b_{k+1}, \dots, b_n . Now we make an assumption that $n > 3$. In this case, as $l_2 = 2$ and $M_{2j} = 1$ for all $j \leq n$, we can conclude that there is a curve α_3 enclosing boundary components b_2, b_{k+1}, \dots, b_n . This contradicts the fact that $M_{k+1,n} = 1$ as in this case α_2 and α_3 are curves containing both the boundary components. If $k + 1 = n$, then instead of the boundary components b_2 we apply the same argument to boundary component b_n . In this case, α_3 will enclose boundary components b_2, \dots, b_n which is a contradiction to the fact that $M_{2(n-1)} = 1$, unless $n = 3$. In the case that, $n = 2$ there is nothing to prove as $M_{12} = 1$ would imply that there is a unique curve. This proves part 1 of the lemma.

When $n = 3$ and $l_i = 2$, we see that there is a configuration of curves, α_1 enclosing boundary components b_1 and b_2 , α_2 enclosing boundary components b_1 and b_3 and curve α_3 enclosing boundary components b_2 and b_3 , satisfying the given multiplicities conditions. In this case all the multiplicities, M_{ij} and M_i are satisfied for all i and j .

Observe that a priori we do not know the order in which $\tau_{\alpha_1}, \tau_{\alpha_2}$ and τ_{α_3} appear in the factorization of Φ' . We can always rearrange the terms such that Φ' is given by $\tau_{\alpha_1}\tau_{\alpha_2}\tau_{\alpha_3}$. For example, if $\Phi' = \tau_{\alpha_2}\tau_{\alpha_1}\tau_{\alpha_3}$, then we can rearrange this as $\Phi' = \tau_{\alpha_1}\tau_{\alpha_1}^{-1}\tau_{\alpha_2}\tau_{\alpha_1}\tau_{\alpha_3} = \tau_{\alpha_1}\tau_{\tau_{\alpha_1}^{-1}(\alpha_2)}\tau_{\alpha_3}$. Noting that conjugating by $\tau_{\alpha_1}^{-1}$ does not change the boundary components enclosed by the curve α_2 , we still call this new curve α_2 . This proves part 2 of the lemma.

□

Remark 8.2.5. *As seen in the proof above, we can always reorder the elements in*

factorization upto conjugation since we are only concerned with factorizations up to Hurewitz equivalence. Henceforth, we will assume that the Dehn twists are arranged in the order as in the statement of theorems.

Now we give a generalization of this lemma. Here we assume that $n \geq 3$. It is very easy to see, from the proof of the lemma above, that when $n \leq 2$ there is a unique positive factorization of any given element of the mapping class group as every Dehn twist is boundary parallel.

Lemma 8.2.6. *Assume that $n \geq 3$. Let $\Phi = \tau_{b_1}^r \tau_{b_2} \tau_{b_3} \dots \tau_{b_{n+1}}$, where $r > 1$, be an element of $Map(\mathbb{D}_n, \partial\mathbb{D}_n)$. If Φ' is any other positive factorization of Φ , then following holds:*

1. *If $r \geq n - 2$, then the factorization Φ' , up to Hurewitz equivalence, is given by $\tau_{b_1}^r \tau_{b_2} \tau_{b_3} \dots \tau_{b_{n+1}}$ or by the product of following Dehn twists $\tau_{\alpha_1}, \tau_{\alpha_2}, \dots, \tau_{\alpha_{n-1}}, \tau_{\gamma}, \tau_{b_1}^{(r-n+2)}$ where α_i are curves enclosing boundary components b_1 and b_{i+1} only and γ is a curve which encloses boundary components b_2, b_3, \dots, b_n .*
2. *If $r < n - 2$, then the factorization Φ' , up to Hurewitz equivalence, is given by product of following Dehn twists $\tau_{b_1}^r, \tau_{b_2}, \tau_{b_3}, \dots, \tau_{b_{n+1}}$.*

Proof. We proceed as in the proof of previous lemma. Let $\Phi' = \tau_{\gamma_1} \tau_{\gamma_2} \dots \tau_{\gamma_m}$ be any other positive factorization of Φ . Let l_i be the number of curves enclosing the boundary component b_i and at least one other boundary component, for every i . We know from the given factorization that $M_{ij}(\Phi) = M_{ij}(\Phi') = 1$ for all i, j and $M_i(\Phi) = M_i(\Phi') = 2$ for all $i > 1$. We get the following set of relations as before

$$1 \leq l_i \leq 2 \text{ for all } i \geq 2$$

$$1 \leq l_1 \leq (r + 2)$$

If $l_i = 1$ for some i , then we will prove $l_j = 1$ for all $j \geq 2$. Let β_i be the unique curve enclosing the boundary component b_i . By counting multiplicities (joint and

individual) we see that this curve must include all the n boundary components in the disk. Again all the joint multiplicities are satisfied and so only other curves enclosing boundary components b_j for $j \neq i$ are the boundary parallel curves. Hence $l_j = 1$ for all j . So we get the unique factorization in this case, by adding the needed boundary Dehn twists.

Now assume that $l_i = 2$. Let β_1, β_2 be the curves which enclose boundary component b_n . As argued in the proof of previous lemma, β_1 and β_2 have only the boundary component b_n in common. Without loss of generality, we can assume that β_1 encloses boundary components $b_n, b_1, b_2, \dots, b_k$ and β_2 encloses boundary components $b_{k+1}, \dots, b_{n-1}, b_n$. Here $k < (n - 1)$. Let us assume first that $k > 1$. So at least the boundary component b_2 is enclosed by β_1 . From the fact that $l_2 = 2$ we get that there has to be a curve, say β_3 enclosing boundary components b_2 and b_{k+1}, \dots, b_{n-1} . This contradicts the fact that $M_{(k+1)(n-1)} = 1$ except when $(k + 1) = (n - 1)$. In this case, as $M_{(n-2)1} = 1$, we conclude that either curve β_3 encloses boundary component b_1 also or there is another curve β_4 enclosing boundary components b_{n-1} and b_1 . Note that β_4 can enclose more boundary components than only these two boundary components. In first case we get a contradiction to the fact that $M_{12} = 1$. In the second case, we get a contradiction to the fact that $l_{(n-1)} = 2$.

Now assume that β_1 encloses boundary components b_n and b_1 . In this case, from conditions on multiplicities of boundary components and l_i , it is easy to see that there has to be curves $\gamma_1, \gamma_2, \dots, \gamma_{n-2}$ such that γ_i encloses boundary components b_1 and b_{i+1} only. This is possible only if $r + 2 \geq n$. This proves the lemma. □

Refer to Figure 10 for the notations used in following lemma.

Lemma 8.2.7. *Let α and β be curves as shown in Figure 10. Assume that $k < n$.*

Let

$$\Phi = \tau_\alpha \tau_\beta \tau_{b_1}^{r_1} \tau_{b_2}^{r_2} \dots \tau_{b_{(k-1)}}^{r_{(k-1)}} \tau_{b_{(k+1)}}^{r_{(k+1)}} \dots \tau_{b_n}^{r_n}$$

be an element of $\text{Map}(\mathbb{D}_n, \partial\mathbb{D}_n)$. Here $r_i \geq 0$ for all $i \neq k$. If Φ' is any other positive factorization of Φ , then Φ' is given by product of following Dehn twists

$$\tau_{\alpha'}, \tau_{\beta'}, \tau_{b_1}^{r_1}, \tau_{b_2}^{r_2}, \dots, \tau_{b_{(k-1)}}^{r_{(k-1)}}, \tau_{b_{(k+1)}}^{r_{(k+1)}}, \dots, \tau_{b_n}^{r_n}$$

such that α', β' enclose the same set of boundary components as α, β respectively.

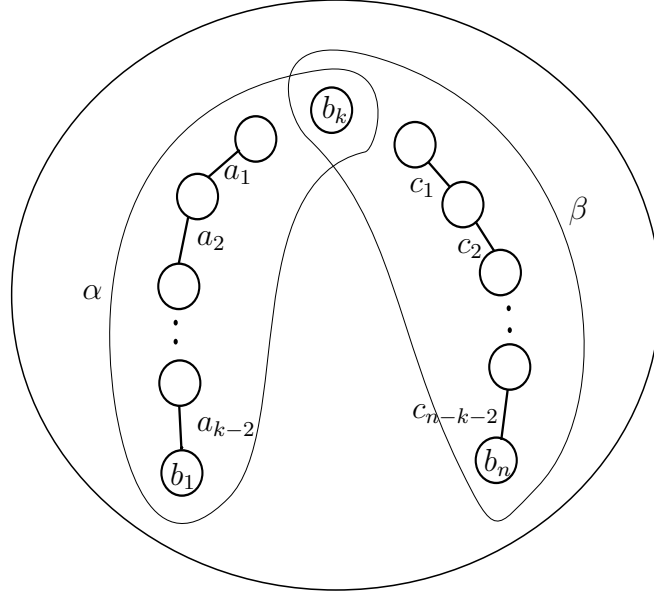

Figure 10: Figure shows the configuration of curves used in Lemma 8.2.7. The arcs a_i and b_i can be cut along to get a disk with 3 boundary components in the proof of Theorem 8.2.9.

Proof. Let l_i be the number of curves enclosing at least 2 boundary components, each containing boundary component b_i . Following the argument given in Lemma 8.2.6, we get $1 \leq l_i \leq (r_i + 1)$ for all $i \neq k$ and $1 \leq l_k \leq 2$. We have the multiplicities $M_{ij} = 1$ for all i, j satisfying $i, j < k$ or $i, j > k$, $M_{ij} = 0$ for all $i < k, j > k$ and $M_i = r_i + 1$ for all i , and $M_{ki} = 2$ for all i . Now we focus on the boundary component b_k . There are two cases:

1. $l_k = 1$: Let us call the curve γ . Since, $M_{ik} = 1$ for all i , we deduce that γ encloses all the boundary components in the disk. This is a contradiction as $M_{1n} = 0$.

2. $l_k = 2$: Let us call the curves γ_1 and γ_2 . Let us assume that γ_1 encloses boundary components b_k, b_i, b_j such that $i < k$ and $j > k$. This is a contradiction to the fact that $M_{ij} = 0$ as observed before. So we can assume that γ_1 encloses boundary components $b_k, b_{i_1}, \dots, b_{i_r}$, such that $i_j < k$ for all $j \in 1, \dots, r$. If γ_1 does not enclose all the boundary components b_1, \dots, b_k , we can assume without loss of generality that γ_1 does not enclose boundary component b_1 at least. In this case, γ_2 will have to enclose boundary components $b_1, b_k, b_{k+1}, \dots, b_n$. A contradiction as $M_{1(k+1)} = 0$. So we get that γ_1 encloses boundary components b_1, \dots, b_k and similarly γ_2 encloses boundary components b_k, \dots, b_n .

So we get that any factorization of Φ' has positive Dehn twists about curves α' and β' as in the statement. We are left to prove that $l_i = 1$ for all $i \neq k$. If not, then without loss of generality we can assume that $l_1 \geq 2$. So the boundary components b_1 is enclosed by curves α' and at least one more curve, γ . By assumption γ has to enclose at least one more boundary component, say b_r , other than b_1 . It is clear that $r > k$. But this is a contradiction as $M_{1r} = 0$. So we get that $l_i = 1$ for all $i \neq k$. Now the statement follows by simple count of multiplicities.

□

Remark 8.2.8. *This is a generalization of Lemma 2.1 of [66]. It is also straightforward to see that the lemma holds in general for finitely many curves rather than just 2 i.e. if $\alpha_1, \dots, \alpha_r$ are curves such that any, α_i, α_j have exactly one boundary component in common (call it b_k) for every i and j , then any factorization of*

$\Phi = \tau_{\alpha_1} \tau_{\alpha_2} \dots \tau_{\alpha_r} \tau_{b_1}^{s_1} \dots \tau_{b_{k-1}}^{s_{(k-1)}} \tau_{b_{k+1}}^{s_{(k+1)}} \dots \tau_{b_n}^{s_n}$ is of the form

$$\Phi' = \tau_{\alpha'_1} \tau_{\alpha'_2} \dots \tau_{\alpha'_r} \tau_{b_1}^{s_1} \dots \tau_{b_{k-1}}^{s_{(k-1)}} \tau_{b_{k+1}}^{s_{(k+1)}} \dots \tau_{b_n}^{s_n}$$

such that α'_i encloses the same set of boundary components as α_i .

Now we are ready to prove the main theorem, which will be used to classify the Stein fillings of lens spaces in Theorem 1.0.5.

Theorem 8.2.9. *Let α and β be the curves as shown in Figure 10. Let*

$$\Phi = \tau_\alpha \tau_\beta \tau_{b_1}^{r_1} \tau_{b_2}^{r_2} \cdots \tau_{b_{k-1}}^{r_{(k-1)}} \tau_{b_{k+1}}^{r_{(k+1)}} \cdots \tau_{b_n}^{r_n}$$

be a monodromy such that $r_i \geq 1$ for all i . Let Φ' be any other positive factorization of Φ . Then there exists a diffeomorphism ψ such that $\Phi = \psi \Phi' \psi^{-1}$.

Proof. By Lemma 8.2.7 above we have that $\Phi' = \tau_{\alpha'} \tau_{\beta'} \tau_{b_1}^{r_1} \tau_{b_2}^{r_2} \cdots \tau_{b_{k-1}}^{r_{(k-1)}} \tau_{b_{k+1}}^{r_{(k+1)}} \cdots \tau_{b_n}^{r_n}$ such that α', β' enclose the same set of boundary components as α, β respectively. Since the boundary Dehn twists do not change in any factorization, we need to find all possible choices for α' and β' to get all factorizations of Φ . Note that $\tau_\alpha \tau_\beta = \tau_{\alpha'} \tau_{\beta'}$. Since curves α and β do not intersect any of the arcs $a_i, 1 \leq i \leq k-2$ and $c_j, 1 \leq j \leq n-k-2$ which are shown in Figure 10, we know that $\tau_\alpha \tau_\beta$ does not move arcs a_i and c_j . Hence it follows that $\tau_{\alpha'} \tau_{\beta'}$ does not move them.

We claim that curves α' and β' do not intersect arcs a_i and c_j . To see this, we proceed by contradiction. Without loss of generality we can assume that β' intersects arc say a_1 . In this case the arc a_1 will be moved strictly to the right by $\tau_{\beta'}$. This follows from the fact that any positive factorization is right veering, see [43] for details. Since $\tau_{\alpha'} \tau_{\beta'}$ does not move the arc a_1 , it will have to be moved left by the other factor $\tau_{\alpha'}$ in $\tau_{\alpha'} \tau_{\beta'}$. This is not possible as every factor is positive and hence right veering. So we get a contradiction. Similarly we can prove that α' and β' do not intersect any of the arcs a_i and c_j . Hence, α' and β' live in the complement of arcs a_i and c_j . So we can cut the surface along a_i and c_j to specify α' and β' . Now the result follows from lantern characterization in Lemma 8.1.1. □

Using this theorem, we can prove the classification of the Stein fillings of virtually overtwisted contact structures on $L(p, 1)$ due to Plamenevskaya and Van Horn-Morris. In addition we can also reprove the classification of the Stein fillings on universally tight $L(p, 1)$ due to McDuff [59].

Corollary 8.2.10. *Let ξ be any tight contact structure on $L(p, 1)$. Then*

1. *The contact structure ξ has a unique Stein filling if $p \neq 4$ upto symplectomorphism.*
2. *The universally tight contact structure on $L(4, 1)$ has exactly two Stein fillings upto symplectomorphism.*
3. *The virtually overtwisted contact structure on $L(4, 1)$ has a unique Stein filling upto symplectomorphism.*

Proof. First consider the case when the contact structure is virtually overtwisted. For this we draw the open book decomposition as shown in Figure 12. We describe the open book first. The left picture shows annulus open book supporting (S^3, ξ_{std}) where the dotted curve α is the Dehn twist curve. The solid curve is the Legendrian unknot $tb = -1$, sitting on the page of this open books. Now one can stabilize this unknot p times as shown in the right by curve β . Dotted curves are the stabilization curves which intersect the co-cores on the 1-handles attached exactly once. By isotoping the whole surface we see that this is exactly the surface described by Figure 10. Now it is easy to see that, monodromy for the contact structures on the lens spaces is given by

$$\Phi = \tau_\alpha \tau_\beta \tau_{b_1} \tau_{b_2} \cdots \tau_{b_{k-1}} \tau_{b_{k+1}} \cdots \tau_{b_n}$$

where α and β are curves as shown in Figure 10 with $n = (p - 1)$. Hence the last statement of the theorem follows from Theorem 8.2.9.

Now consider the case when the contact structure is universally tight on $L(p, 1)$. In this case monodromy is given by $\Phi = \tau_{b_1} \tau_{b_2} \cdots \tau_{b_n} \tau_{b_{n+1}}$ and $n = (p - 1)$. By Lemma 8.2.4, if Φ' is any positive factorization of Φ , then Φ' is Φ except when $p = 4$.

When ξ is a universally tight contact structure on $L(4, 1)$. Then we know that either $\Phi = \tau_{b_1} \tau_{b_2} \tau_{b_3} \tau_{b_4}$ which by lantern relation is same as $\tau_\alpha \tau_\beta \tau_\gamma$, with α, β, γ as

shown in Figure 9. By Lemma 8.2.4 we know that any other factorization of Φ is of the form $\tau_{\alpha'}\tau_{\beta'}\tau_{\gamma'}$ where α' is a curve that encloses boundary components b_1 and b_2 , β' is a curve that encloses boundary components b_1 and b_3 and γ' is a curve that encloses boundary components b_2 and b_3 . In the second case the lantern characterization given in Lemma 8.1.4, implies that there exists a diffeomorphism $\psi \in \text{Map}(\mathbb{D}_3, \partial\mathbb{D}_3)$ such that $\alpha' = \psi(\alpha), \beta' = \psi(\beta), \gamma' = \psi(\gamma)$. Hence, we get that there are exactly two factorizations of Φ upto diffeomorphism and exactly two Stein fillings upto symplectomorphism.

□

After proving the known results using our techniques, we classify the Stein fillings of any contact structure on $L(p(m+1)+1, (m+1))$.

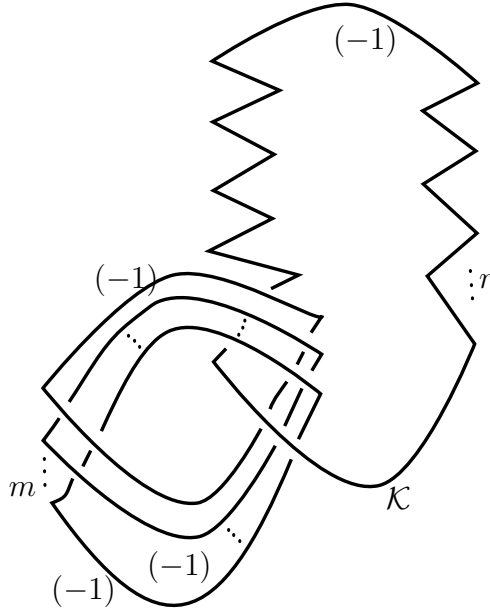

Figure 11: Surgery diagram for lens spaces $L(p(m+1)+1, m+1)$. In the diagram \mathcal{K} is the maximal tb unknot stabilized positively r times and negatively $p-r-1$ times. As we vary r from 0 to $p-1$ we get all the contact structures on these lens spaces.

Proof of Theorem 1.0.5. From the classification given in [42], we can draw the Legendrian surgery diagram for various contact structures on $L(p(m+1)+1, (m+1))$ as shown in Figure 11. Now we draw the open book decomposition corresponding

to this contact manifold. This is exactly the same as described in Corollary 8.2.10. Figure 12 shows the open book. The boundary parallel curves which are not dotted are m Legendrian unknots with $tb = -1$. We see that this is exactly the surface described by Figure 10.

When $r = 1$, the contact structure is universally tight. For the universally tight contact structure the monodromy is $\Phi = \tau_{b_1}^{m+1} \tau_{b_2} \dots \tau_{b_n}$ and the page of the open book decomposition is \mathbb{D}_n with $n = p - 1$. By Lemma 8.2.6 above, we have that any other factorization Φ' is $\tau_{b_1}^{m+1} \tau_{b_2} \dots \tau_{b_n}$ when $p > m + 4$. Hence, we get the uniqueness of the Stein filling as the factorization is unique. When $p \leq m + 4$, we have by Lemma 8.2.6, that there is another factorization $\Phi' = \tau_{\alpha'_1} \tau_{\alpha'_2} \dots \tau_{\alpha'_{p-2}} \tau_{\gamma'} \tau_{b_1}^{(r-p+3)}$, where α'_i are curves enclosing boundary components b_1 and b_i for every i and γ' is a curve enclosing boundary components b_2, b_3, \dots, b_{p-1} . So we have at least 2 Stein fillings. This finishes the proof.

The open book decomposition for virtually overtwisted contact structures is given by Figure 12 with monodromy $\Phi = \tau_\alpha \tau_\beta \tau_{b_1} \tau_{b_2} \dots \tau_{b_{k-1}} \tau_{b_{k+1}} \dots \tau_{b_n}^{m+1}$, where $n = p - 1$ and α and β are curves as shown in Figure 12. In this case, the uniqueness of the Stein filling follows exactly in the same way as above.

□

8.3 *Finiteness of Euler Characteristics and Signature*

In this section we prove Theorem 1.0.1 and Theorem 1.0.3.

Proof of Theorem 1.0.1. Let (X, J) be a Stein filling of a contact manifold (M, ξ) supported by planar open book (\mathbb{D}_n, Φ) . The number of 2-handles is given by the number of vanishing cycles. Hence it follows from Wendl's theorem that, if we bound the number of vanishing cycles we will have a bound on the Euler characteristic of the given Stein filling. In other words, if we can bound the number of Dehn twists in any positive factorization of Φ we get an upper bound on the Euler characteristic of

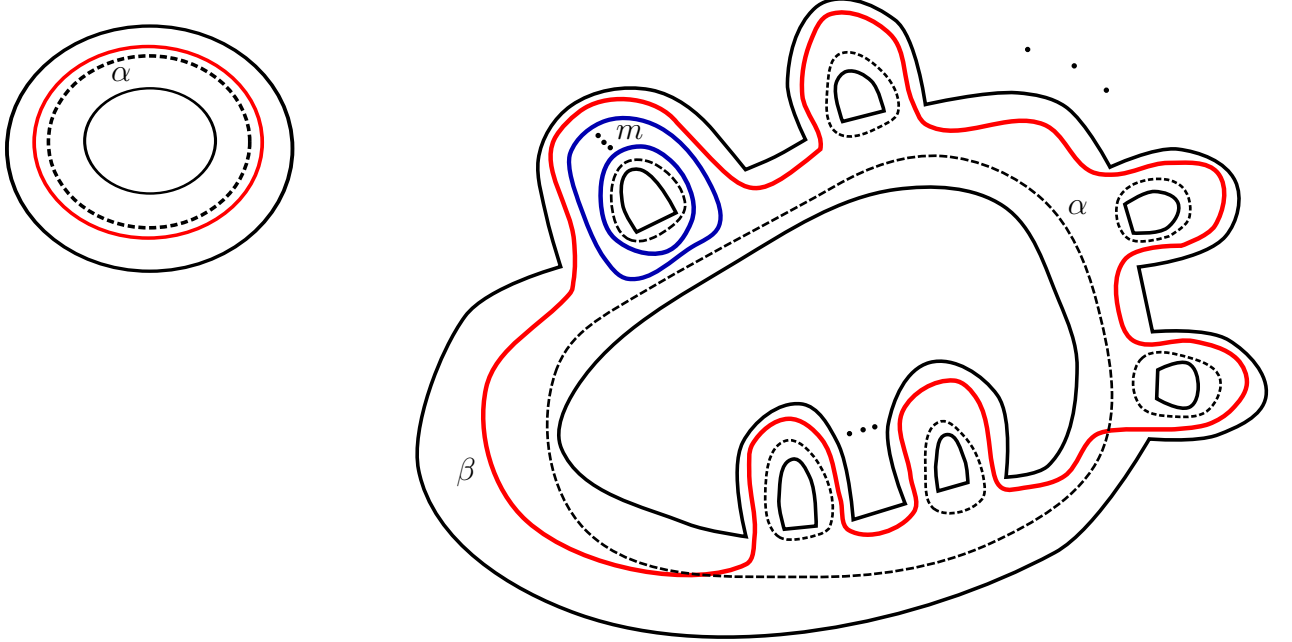

Figure 12: Open book for (S^3, ξ_{std}) on left and open book supporting the lens space $L(p(m+1)+1, (m+1))$ is shown.

(X, J) .

Let M_i denote the multiplicity of each boundary component, as defined in Section 8.2, in this factorization. By the definition of multiplicity of a boundary component, in any factorization Φ' of Φ there cannot be more than M_i positive Dehn twists about curves enclosing the boundary component b_i . Hence, $M_1 + M_2 + \dots + M_n$ gives an upper bound on the number of two handles attached. This gives an upper bound on $\chi(X)$.

Now we are left to bound the signature of the Stein filling. Recall that Euler characteristic of a Stein manifold X can be written as $\chi(X) = 1 - b_1(X) + b_2^+(X) + b_2^-(X) + b_2^0(X)$. Using Theorem 4.1 of [20], which states that for a manifold supported by planar open book any Stein filling has vanishing b_2^+ and b_2^0 , we get that $\chi(X) = 1 - b_1(X) + b_2^-(X)$. Hence, $\sigma(X) + \chi(X) = 1 - b_1(X) + b_1^+(X)$. Now for the 4-manifold X , a simple homology computation shows that $|H_1(X)| \leq n$ and so $1 - b_1(X)$ is bounded. It follows that $|\sigma(X) + \chi(X)| < M$ for some M . Now by finiteness of

$\chi(X)$ we get that $|\sigma(X)| < M + |\chi(X)|$. Hence, there exists a constant N such that $|\sigma(X)| < N$ and $|\chi(X)| < N$. It follows that $\mathcal{C}_{(M,\xi)}$ is finite. \square

Remark 8.3.1. *After proving the above theorem, the author found another proof of this result. Stipsicz [69] proved that $\mathcal{C}_{(M,\xi)}$ is finite for any manifold (M,ξ) for which every Stein filling has $b_2^+ = 0$. Now the above mentioned theorem of Etnyre [20] implies that for any manifold supported by planar open book $b_2^+ = 0$. Hence, the theorem follows by combining these two results.*

For proving Theorem 1.0.3 we need a version of Wendl's theorem for spinal open books. If the fibers \hat{F} of a spinal open book has a planar component, then Wendl's theorem can be generalised.

Theorem 8.3.2 (Lisi-Van Horn-Morris-Wendl, [53]). *If the spinal open book $(\hat{F}, \text{hat}\phi, \hat{\Sigma}, G)$ has a planar component to \hat{F} , then any symplectic filling of the contact manifold (M, ξ) supported by $(\hat{F}, \hat{\phi}, \hat{\Sigma}, G)$ admits a Lefschetz fibration whose boundary is $(\hat{F}, \hat{\phi}, \hat{\Sigma}, G)$.*

Before we prove the finiteness results for spinal open books, we recall a theorem of Wand [75] and state it in a more general form suitable for applications to our purposes. The proof essentially is the same as given by Wand in [75] but we give a sketch here for completeness.

Proposition 8.3.3. *Let (M, ξ) be a contact manifold supported by a spinal open book with connected binding $\Sigma_{g,r}$ and connected fibers $\Sigma_{0,b}$. If (X_1, J_1) and (X_2, J_2) are any two Stein fillings of (M, ξ) , then $\chi(X_1) + \sigma(X_1) = \chi(X_2) + \sigma(X_2)$.*

Proof. Let us denote by $X_{g,\lambda}^h$, a Lefschetz fibration over a closed surface Σ_h with fibers Σ_g and λ is factorization of identity in $Map(\Sigma_h, \partial\Sigma_h)$. If λ' is obtained from λ by r -substitution (r is a relator in the mapping class group of the surface Σ_g), then a result of Endo and Nagami [17] gives:

$$\sigma(X_{g,\lambda}^h) - \sigma(X_{g,\lambda'}^h) = I(r)$$

where $I(r)$ is the signature of the relator r defined in [17].

With this set-up we can prove following statement which is essentially Theorem 4.4 of [75].

Lemma 8.3.4. *Let $\Sigma = \Sigma_{g,b}$ be a surface with boundary. Let $X_{\Sigma,\lambda}$ and $X_{\Sigma,\lambda'}$ be Lefschetz fibrations over $\Sigma_{h,m}$ such that λ' is an r -substitution of λ . Then*

$$\sigma(X_{\Sigma,\lambda}) - \sigma(X_{\Sigma,\lambda'}) = I(r).$$

Proof of lemma. Starting with a Lefschetz fibration over non-closed surface $\Sigma_{h,m}$ we can construct the closed Lefschetz fibrations $X_{\bar{g},\lambda_1}^h$ and $X_{\bar{g},\lambda'_1}^h$ with genus of fibers $\bar{g} > g$, such that λ'_1 is obtained by an r -substitution from λ_1 in mapping class group of $\Sigma_{\bar{g}}$. To see this, let $\Sigma_{0,b+1}$ be a sphere with 1 more boundary component than the fibers $\Sigma_{g,b}$. Let $\Sigma'' = \Sigma_{g,b} \cup \Sigma_{0,b+1}$ where we glue the boundary components and let $\hat{\Sigma}$ denote the surface obtained by capping off the boundary component of Σ'' with a disk. As $\Sigma_{g,b}$ is a subsurface of Σ'' extending by identity on $\Sigma'' \setminus \Sigma_{g,b}$, both λ and λ' extend to mapping classes on Σ'' . We still call the extensions λ and λ' in the new surface. These extensions are also related by r -substitution in the new mapping class group. It is a well known fact that, any positive mapping class Φ in a genus p surface with 1 boundary component can be written as $\Phi = \tau_\delta^N \hat{\Phi}$, where τ_δ is Dehn twist about the boundary component and $N > 0$ and $\hat{\Phi}$ is a negative mapping class, that is, given as factorization in terms of negative Dehn twists only. Applying this fact gives us $\lambda = \tau_\delta^N \hat{\lambda}$ and so $\lambda \circ \hat{\lambda}^{-1} = \tau_\delta^N$. Hence, $\lambda_1 = \lambda \circ \hat{\lambda}^{-1}$ gives a positive factorization of identity in $Map(\hat{\Sigma})$ and hence a Lefschetz fibration $X_{\bar{g},\lambda_1}^h$. Similarly, $\lambda'_1 = \lambda' \circ \hat{\lambda}^{-1}$ gives a Lefschetz fibration $X_{\bar{g},\lambda'_1}^h$. We note that, in getting the closed Lefschetz fibrations $X_{\bar{g},\lambda_1}^h$ and $X_{\bar{g},\lambda'_1}^h$, we have added the same compact 4 manifold Y . We have,

$$\sigma(X_{\bar{g},\lambda_1}^h) - \sigma(X_{\bar{g},\lambda'_1}^h) = I(r).$$

So by Novikov additivity we have, $I(r) = \sigma(X_{\bar{g},\lambda_1}^h) - \sigma(X_{\bar{g},\lambda'_1}^h) = \sigma(X_{\Sigma,\lambda}) + \sigma(Y) - \sigma(X_{\Sigma,\lambda'}) - \sigma(Y)$ and the result follows. \square

To get the result for spinal open books with planar fibers, we apply Theorem 8.3.2, and note that any relator in a planar surface is a concatenation of lantern relator. See [17] for calculations of signatures of various relators in mapping class groups. From these computation we know that for a lantern relator the signature $I(r) = 1$ or -1 , depending on the particular substitution performed. If the lantern relator has signature 1, the Euler characteristic of the new manifold changes by -1 . In the other case, the Euler characteristic changes by 1. In either case one sees that the following equality holds for each lantern substitution.

$$\sigma(X_{\Sigma,\lambda}) - \sigma(X_{\Sigma,\lambda'}) = \chi(X_{\Sigma,\lambda'}) - \chi(X_{\Sigma,\lambda}).$$

Since any relator in a planar surface is a concatenation of lantern relators, we see that the above equality holds at each stage. \square

Now we are ready to prove the finiteness of the Euler characteristic and the signature of the Stein filling of spinal open books. Just as in the proof of Theorem 1.0.1, we will bound the number of 2-handles to get an upper bound on the Euler characteristic of Stein filling (X, J) .

Proof of Theorem 1.0.3. The monodromy of a Lefschetz fibration over a genus g surface with fiber Σ_h is given by

$$w = \prod_{i=1}^m \tau_{v_i} \prod_{j=1}^g [\alpha_j, \beta_j]$$

where $\alpha_1, \dots, \alpha_g, \beta_1, \dots, \beta_g$ are images of generators of fundamental group in $Map(\Sigma_h, \partial\Sigma_h)$ and $\tau_{v_1}, \dots, \tau_{v_m}$ are Dehn twists about vanishing cycles. To construct this manifold,

we start with a surface bundle over the g surface. This is described by the monodromy $\prod_{j=1}^g [\alpha_j, \beta_j]$. This manifold has a finite Euler characteristic independent of α_j and β_j . To get the Lefschetz fibration we attach 2-handles along the vanishing cycles prescribed by curves v_i . Hence to bound the Euler characteristic again we need to bound the number of vanishing cycles. In the abelianization of the mapping class group of a planar surface w has an image $\tau_{v_1}^-, \dots, \tau_{v_m}^-$, where $\tau_{v_i}^-$ is image of the Dehn twist in the abelianization. So to bound the Euler characteristic of the Stein filling, it suffices to bound the number of terms in the factorization $\tau_{v_1}^-, \dots, \tau_{v_m}^-$. This is done in exactly the same way as in the proof of Theorem 1.0.1. So we get the finiteness of $\chi(X)$. Now from Proposition 8.3.3 we see that $\sigma(X)$ is also bounded.

□

8.4 Euler characteristic of sphere plumbings

In this section we prove Theorem 1.0.4. Gay and Mark [29] explicitly write down the open book decomposition for the boundary of a plumbing of spheres. The open book decomposition for (M, ξ_{pl}) which is contactomorphic to boundary of (Z, η) which is a neighbourhood of spheres $C = C_1 \cup C_2 \cup \dots \cup C_n$, intersecting ω -orthogonally, along the negative definite graph Γ is given as follows. Recall from Chapter 1, that we assume that the row sum satisfies $s_i = \sum_j q_{ij} \leq 0$, where $Q = (q_{ij} = [C_i] \cdot [C_j])$ is the intersection matrix. Let S be the result of connect summing $|s_i|$ copies of D^2 to each C_i and then connect summing these surfaces according to Γ . It is clear from this construction that S is a disk with a finitely many open disks removed from the interior when C_i are all spheres. Let $\{c_1, c_2, \dots, c_k\}$ be the collection of simple closed curves on S consisting of one curve around each connect sum neck. It is clear from the construction that c_i are all disjoint. Let τ denote the product of Dehn twists along these curves. The following theorem is proved in [29].

Theorem 8.4.1. *Any neighbourhood of C contains a neighbourhood (Z, η) of C with*

strongly convex boundary, that admits a symplectic Lefschetz fibration $\pi : Z \rightarrow D^2$ having regular fiber S and exactly one singular fiber $S_0 = \pi^{-1}(0)$. The vanishing cycles for π are c_1, \dots, c_k and the induced contact structure ξ_{pl} on ∂Z is supported by the induced (S, τ) .

To prove the Theorem 1.0.4, we first prove following fact about positive factorizations in planar mapping class group.

Theorem 8.4.2. *Assume that $\phi \in \text{Map}(\mathbb{D}_n, \partial\mathbb{D}_n)$ can be written as a product of positive Dehn twists about disjoint curves, i.e. $\phi = \tau_{c_1}\tau_{c_2}\dots\tau_{c_k}$, such that c_i are all disjoint. If $\tau_{d_1}\tau_{d_2}\dots\tau_{d_m}$ is any other positive factorization of ϕ , then $m \leq k$.*

Proof. The proof is by induction on the number of holes, n , of the disk and the number of curves k .

We start by proving the base cases. There are two base cases to be checked.

- **Disk with 1 hole:** Let us denote the hole by b_1 . Now $\Phi = \tau_{b_1}^p$ for some $p \in \mathbb{Z}_{\geq 0}$. Any other positive factorization has to be Dehn twists about the hole b_1 . So the argument is trivial in this case.
- **Disk with $n > 1$ holes and $k = 1$:** In this case $\phi = \tau_\alpha$ for some curve α . We can assume that the curve α encloses the boundary components b_1, b_2, \dots, b_l for some $l \leq n$. If $l = n$ then the curve α is boundary parallel to the outer boundary component b_{n+1} and so a positive factorization of ϕ is unique. So we can assume $l < n$. In this case the joint multiplicity of $M_{ij} = 0$ for $i \leq l$ and $j > l$. So a positive factorization of ϕ cannot include Dehn twists about curves enclosing any of the holes b_{l+1}, \dots, b_n . Also since the multiplicity $M_i = 1$ of each holes b_1, \dots, b_l , we know that there can be no more than one curve enclosing holes any of the holes b_1, \dots, b_l in any positive factorization of ϕ . In addition, since the joint multiplicity of all these holes is 1, so there must be exactly 1 curve enclosing the holes b_1, \dots, b_l in any positive factorization of ϕ .

Now by induction we assume that the theorem is true for:

1. All planar surfaces with $n - 1$ holes.
2. Any ϕ in $Map(\mathbb{D}_n, \partial\mathbb{D}_n)$, with a positive factorization such that the Dehn twists are about $k - 1$ disjoint curves in the surface \mathbb{D}_n .

In the surface \mathbb{D}_n , let $\phi = \tau_{c_1}\tau_{c_2}\dots\tau_{c_k}$ be an element of the mapping class group such that c_i 's are all disjoint. Let us assume that there is a positive factorization of ϕ given by $\tau_{d_1}\tau_{d_2}\dots\tau_{d_m}$ with $m > k$. If there is any hole b_i with multiplicity 0, then we can cap off the hole b_i and this gives a contradiction to the induction hypothesis 1. So we can assume that multiplicity of each of the holes b_1, \dots, b_n is at least 1. Let us start by looking at the hole b_1 . If there is a boundary parallel Dehn twist τ_{b_1} in both the factorizations of ϕ given above, then we can cancel the boundary Dehn twist and get a contradiction to the induction hypothesis 2. So τ_{b_1} can never appear in both the factorizations of ϕ . Let us assume that τ_{b_1} appears in the factorization $\tau_{c_1}\tau_{c_2}\dots\tau_{c_k}$. In this case we can cap off the hole b_1 and get a contradiction to the induction hypothesis 1, as capping off the hole b_1 reduces the number of factors in $\tau_{c_1}\tau_{c_2}\dots\tau_{c_k}$ by 1, but does not reduce the number of factors in $\tau_{d_1}\tau_{d_2}\dots\tau_{d_m}$. Now we argue that there is at least one factor of τ_{b_1} in the positive factorization $\tau_{d_1}\tau_{d_2}\dots\tau_{d_m}$. If not then by capping off the hole b_1 we will not reduce the number of factors in both the factorizations of ϕ . Again a contradiction to the induction hypothesis 1. The same exact argument holds for each of the holes b_1, \dots, b_{n+1} . So we know that there is at least 1 factor of τ_{b_i} for each $i \in \{1, \dots, n + 1\}$ in the factorization $\tau_{d_1}\tau_{d_2}\dots\tau_{d_m}$. This implies that $M_{ij} \geq 1$ for every $1 \leq i, j \leq n$ since there is a Dehn twist about the outer boundary component b_{n+1} in $\tau_{d_1}\tau_{d_2}\dots\tau_{d_m}$.

Now since there are no Dehn twists about boundary parallel curves in $\tau_{c_1}\tau_{c_2}\dots\tau_{c_k}$, we know that there is a curve α in c_1, \dots, c_k which encloses a proper subset of holes. Without loss of generality we can assume that α enclosed holes b_1, \dots, b_l for some

$l < n$. Since the curves c_1, \dots, c_k are disjoint there is no curve enclosing any of the holes b_1, \dots, b_l and at least one of the holes b_{l+1}, \dots, b_n . If there is such a curve β , then β will intersect α non trivially, which is not possible. So we can find at least two holes, amongst b_1, \dots, b_n , which are never enclosed together by any of the curves c_1, \dots, c_k . So there is a pair of holes, call them b_{l_1} and b_{l_2} , such that $M_{l_1 l_2} = 0$. A contradiction to the fact that $M_{ij} \geq 1$ for every $1 \leq i, j \leq n$ observed above. \square

Proof of Theorem 1.0.4. If (X, J) is any other strong symplectic filling of (M, ξ_{pl}) , then it has an open book decomposition with page S constructed above and the monodromy which is a positive factorization $\tau_{d_1} \tau_{d_2} \dots \tau_{d_m}$ of τ . So we conclude that, $\chi(X) = 1 + (n - 1) + m$. By the construction of Z as described in the beginning of this section, we know that $\chi(Z) = 1 + (n - 1) + k$. We know from the theorem above that $m \leq k$. The proof follows easily.

\square

CHAPTER IX

STEIN FILLINGS OF MANIFOLDS OBTAINED BY LEGENDRIAN SURGERIES ALONG KNOTS

In this chapter we prove our results about surgeries along knot families that are mentioned in Chapter 1. All these results are based on joint work with Youlin Li.

The contact manifolds we are going to consider are supported by particular open books, which we describe now. Let Σ be a compact planar surface with $n + p + q + 1$ boundary components $c_0, c_1, \dots, c_{n+p+q}$ as shown in Figure 13, where $n, k, p, q \geq 1$ and $n \geq k$. Let Φ be a diffeomorphism which is a composition of right handed Dehn twists written as

$$\Phi = \tau_1^{m_1} \tau_2^{m_2} \dots \tau_{n+q-1}^{m_{n+q-1}} \tau_{n+q+1}^{m_{n+q+1}} \dots \tau_{n+p+q}^{m_{n+p+q}} \tau_{B_1} \tau_{B_2},$$

where τ_i is the positive Dehn twist about a simple closed curve parallel to the boundary component c_i , $m_i \geq 0$, and τ_{B_1}, τ_{B_2} are positive Dehn twists along the simple closed curves B_1 and B_2 shown in Figure 13.

Theorem 9.0.3. *Let (M, ξ) be the contact 3-manifold supported by the open book (Σ, Φ) . Then the contact 3-manifold (M, ξ) admits a unique Stein filling up to diffeomorphism.*

9.1 Classification of Stein fillings

We begin by observing a purely combinatorial lemma. The purpose of this lemma is to get restrictions on the curves which can appear in any positive factorization of the given monodromy in terms of Dehn twists. Refer to Figure 13 for the notation used below.

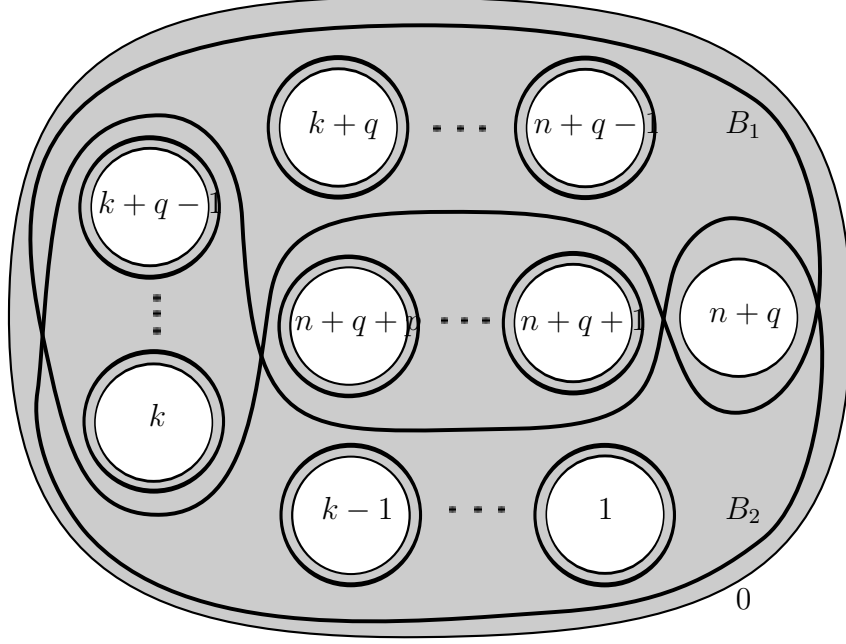

Figure 13: A compact planar surface Σ with $n + q + p + 1$ boundary components.

Lemma 9.1.1. *Any positive factorization of Φ must be given by the product of Dehn twists $\tau_1^{m_1}, \tau_2^{m_2}, \dots, \tau_{n+q-1}^{m_{n+q-1}}, \tau_{n+q+1}^{m_{n+q+1}}, \dots, \tau_{n+p+q}^{m_{n+p+q}}$, and the Dehn twists $\tau_{B'_1}$ and $\tau_{B'_2}$ where B'_1 encloses the same holes as B_1 , and B'_2 the same holes as B_2 .*

Proof. Recall from Section 8.2 that, $M_{i,j}$ denotes the joint multiplicity of the mapping class Φ about the i^{th} and j^{th} boundary components, and M_i denotes the multiplicity of the mapping class Φ about the i^{th} boundary component.

Since $M_{n+q} = 2$ and $M_{i,n+q} = 2$ for $i \in \{k, k+1, \dots, k+q-1\}$, there are exactly two monodromy curves, say B'_1 and B'_2 , enclosing c_{n+q} and c_i for $i \in \{k, k+1, \dots, k+q-1\}$. Since $M_{n+q,j} = 0$ for $j \in \{n+q+1, n+q+2, \dots, n+q+p\}$, $M_{r,n+q} = 1$ for $r \in \{1, \dots, k-1, k+q, \dots, n+q-1\}$, and $M_{s,t} = 0$ for $s \in \{1, \dots, k-1\}$ and $t \in \{k+q, \dots, n+q-1\}$, the two monodromy curves B'_1 and B'_2 enclose $\{c_1, \dots, c_k, c_{k+q-1}, c_{n+q}\}$ and $\{c_k, \dots, c_{n+q-1}, c_{n+q}\}$ respectively.

For $j \in \{n+q+1, n+q+2, \dots, n+q+p\}$, $M_j = m_j$ and $M_{i,j} = 0$ for any $i \in \{1, 2, \dots, n+q+p\}$ and $i \neq j$. So c_j is enclosed solely by m_j boundary parallel

monodromy curves.

For $i \in \{1, \dots, n+q-1\}$, there are no non-boundary-parallel monodromy curves, other than B'_1 and B'_2 , enclosing c_i . Suppose otherwise, then for some $j, h \in \{1, \dots, n+q-1\}$, there is a monodromy curve, other than B'_1 and B'_2 , enclosing c_j and c_h . If either j or h do not belong to $\{k, k+1, \dots, k+q-1\}$, then j and h cannot belong to $\{1, \dots, k-1\}$ and $\{k+q, \dots, n+q-1\}$, respectively. So $M_{j,h} \geq 2$. However, from the original positive decomposition of Φ , we have $M_{j,h} = 1$. So we arrive at a contradiction. If both j and h belong to $\{k, k+1, \dots, k+q-1\}$, then $M_{j,h} \geq 3$. However, also from the original positive decomposition of Φ , we have $M_{j,h} = 2$. So we arrive at a contradiction as well.

Hence for $i \in \{1, \dots, n+q-1\}$, there are m_i boundary parallel monodromy curves enclosing c_i . □

Remark 9.1.2. *With the notation as in the lemma above, any other factorization of Φ can be written as $\tau_1^{m_1} \tau_2^{m_2} \dots \tau_{n+q-1}^{m_{n+q-1}} \tau_{n+q+1}^{m_{n+q+1}} \dots \tau_{n+p+q}^{m_{n+p+q}} \tau_{B'_1} \tau_{B'_2}$ up to Hurwitz equivalence. To see this, recall that since boundary Dehn twists commute with every diffeomorphism we can move them all to the left in the factorization as written above. Now the product of Dehn twists $\tau_{B'_1}$ and $\tau_{B'_2}$ is on the right side of this positive factorization. Hurwitz move on the product of Dehn twists can potentially change the homotopy class of both the curves B'_1 and B'_2 , to say B''_1 and B''_2 . But still B''_i enclose the same set of holes as B'_i for $i = 1, 2$. With abuse of notation we still call these new set of curves as B'_1 and B'_2 , as Lemma 9.1.1 only specifies the curves B'_1 and B'_2 up to the set of holes enclosed by each of these holes. So using commutativity of boundary parallel Dehn twists and Hurwitz moves one can arrange the factorization as above.*

In our case, since we only have two non boundary parallel monodromy curves, a Hurwitz move is also a global conjugation.

9.1.1 The positive factorizations.

In this subsection, we prove that $\tau_{B_1}\tau_{B_2}$ has at most 2 different positive factorizations, up to a global conjugation, in $Map(\Sigma, \partial\Sigma)$ for some simple cases of the surface Σ . We will reduce the above factorization to problem to these simple cases later.

In proving these results, first step will be to get restrictions on intersection number of curves B'_1 and B'_2 . To make sense of intersection numbers of curves, we assume for the rest of the thesis that any two curves are isotoped to intersect minimally.

Lemma 9.1.3. *Let Σ be the surface in Figure 13 with $k = 1$ and $n = 1$. Suppose $p = q = 1$. Then $\tau_{B_1}\tau_{B_2} \in Map(\mathbb{D}_3, \partial\mathbb{D}_3)$ has at most two positive factorizations up to a global conjugation.*

Proof. Since $k = n = 1$, there is no hole which is enclosed by B_2 but not by B_1 , and there is no hole which is enclosed by B_1 but not by B_2 .

By Lemma 9.1.1, any positive factorization of $\tau_{B_1}\tau_{B_2}$ is $\tau_{B'_1}\tau_{B'_2}$ up to a global conjugation, where B'_1 and B'_2 enclose the same set of holes as B_1 and B_2 , respectively.

We assume that each of the boundary components is filled by a disk with one puncture. To avoid confusion, we will still call this surface \mathbb{D}_3 . Note that the curves B_1 and B_2 fill the surface \mathbb{D}_3 . As explained in [27, Exposé 13], one can construct a singular flat Euclidean structure and a representation of the subgroup of $Map(\mathbb{D}_3, \partial\mathbb{D}_3)$ generated by τ_{B_1} and τ_{B_2} . Now Thurston's theorem 6.0.31, implies τ_{B_1} has affine

representative given by $\begin{bmatrix} 1 & 4 \\ 0 & 1 \end{bmatrix}$, and τ_{B_2} has an affine representative $\begin{bmatrix} 1 & 0 \\ -4 & 1 \end{bmatrix}$. Thus,

we obtain an affine representative for $\tau_{B_1}\tau_{B_2}$. It is $\begin{bmatrix} -15 & 4 \\ -4 & 1 \end{bmatrix}$. This matrix has trace -14 , so $\tau_{B_1}\tau_{B_2}$ has a pseudo-Anosov representative with stretch factor the larger of the absolute values of the two eigenvalues, that is $7 + 4\sqrt{3}$. Note that the stretch factor of a pseudo-Anosov representative of a pseudo-Anosov diffeomorphism is in

fact an invariant of the pseudo-Anosov diffeomorphism. This is because two homotopic pseudo-Anosov representatives are conjugate by a diffeomorphism isotopic to the identity ([27, Théorème 12.5]), and any two conjugate pseudo-Anosov representatives have the same stretch factors ([26, Page 406]).

Since $\tau_{B'_1}\tau_{B'_2} = \tau_{B_1}\tau_{B_2}$, is also pseudo-Anosov, B'_1 and B'_2 have to intersect and fill the surface \mathbb{D}_3 . Otherwise there is a non-boundary-parallel simple closed curve which is invariant by $\tau_{B'_1}\tau_{B'_2}$. This is impossible for a pseudo-Anosov diffeomorphism.

Assume that $I(B'_1, B'_2) = z$, where z is a non-negative integer. As above we obtain the affine representative for $\tau_{B'_1}\tau_{B'_2}$. It is $\begin{bmatrix} 1 & z \\ 0 & 1 \end{bmatrix} \begin{bmatrix} 1 & 0 \\ -z & 1 \end{bmatrix} = \begin{bmatrix} 1 - z^2 & z \\ -z & 1 \end{bmatrix}$. Since $\tau_{B'_1}\tau_{B'_2} = \tau_{B_1}\tau_{B_2}$, they have the same stretch factors. So $\frac{1}{2}(z^2 - 2 + z\sqrt{z^2 - 4}) = 7 + 4\sqrt{3}$, and $z = 4$.

Now we conjugate $\tau_{B'_1}\tau_{B'_2}$ by a diffeomorphism which takes B'_1 to B_1 , and B'_2 to a curve B''_2 . We know that B''_2 and B_1 intersect in exactly 4 points. Since B''_2 and B_2 represent the same homological classes in $H_1(\mathbb{D}_3)$, we know that the algebraic intersection number of B''_2 and B_2 with each nontrivial arc in the surface is the same. In particular, for the arc γ shown in the left of Figure 14, the algebraic intersection number of B''_2 and γ is 0, and the geometric intersection number of B''_2 and γ is even.

If $I(B''_2, \gamma) = 0$, then it is easy to see that B''_2 is isotopic to B_1 . This is impossible by the above argument.

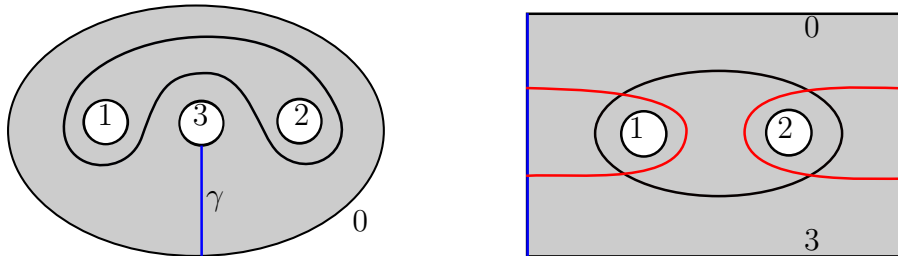

Figure 14: Arc γ along which the surface is cut open is shown in the left picture. The right picture shows the cut open surface.

Suppose $I(B_2'', \gamma) \geq 2$. We cut the surface \mathbb{D}_3 open along the arc γ , and think of the resulting surface as a pair of pants with the outer boundary drawn as a rectangle. See the right of Figure 14. Under this operation, B_2'' is cut into a collection of properly embedded arcs which are pairwise disjoint. Each of these arcs is one of the following three types.

- **Type I:** Both end points of the arc are on the left edge of the rectangle.
- **Type II:** Both end points of the arc are on the right edge of the rectangle.
- **Type III:** The arcs have one end point on the left edge and the other on the right edge of the rectangle.

Since B_1 is parallel to the outer boundary of the rectangle, each of Type I, II and III arcs intersects the curve B_1 in 2 points or is disjoint with B_1 . It is easy to see that each of Type I, II, and III arcs intersects the curve B_1 in exactly 2 points.

For B_2'' to be a simple closed curve enclosing holes c_1 and c_2 , there is at least one arc of Type I and at least one arc of Type II. Since $I(B_2'', B_1) = 4$, B_2'' is cut open into a Type I arc and a Type II arc.

If the Type I arc encloses the hole c_1 with the left edge of the rectangle, and the Type II arc encloses the hole c_2 with the right edge of the rectangle, then some power of τ_{B_1} will send B_2'' to be the one which is formed by the two arcs shown in the right of Figure 14. Hence $\tau_{B_1}\tau_{B_2}''$ is conjugate to $\tau_{B_1}\tau_{B_2}$.

If the Type I arc encloses the hole c_2 with the left edge of the rectangle, and the Type II arc encloses the hole c_1 with the right edge of the rectangle, then some power of τ_{B_1} will send B_2'' to be the one which is formed by the two arcs shown in the left of Figure 15. So there are at most two choices for the curve B_2'' up to conjugation. Hence, there are at most two different factorizations of $\tau_{B_1}\tau_{B_2}$ up to a global conjugation. □

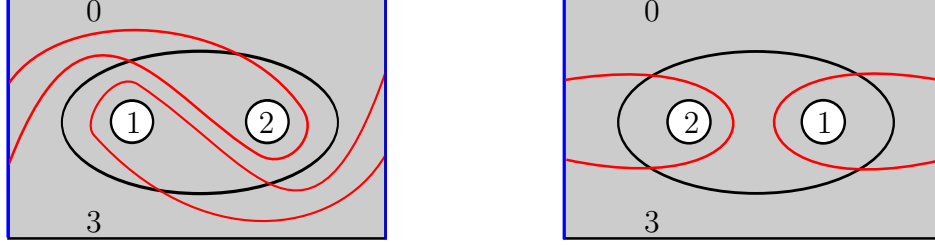

Figure 15: Another choice of the arc for the curve B_2'' shown in the left. The right one is obtained from the left one by a diffeomorphism moving the hole c_1 to the right and the hole c_2 to the left.

Lemma 9.1.4. *Let Σ be the surface in Figure 13 with $k = 1$ or 2 , and $n = 2$. Suppose $p = q = 1$. Then $\tau_{B_1}\tau_{B_2} \in \text{Map}(\mathbb{D}_4, \partial\mathbb{D}_4)$ has at most two positive factorizations up to a global conjugation.*

Proof. If $k = 1$ and $n = 2$, then there is no hole which is enclosed by B_2 but not by B_1 , and there is one hole which is enclosed by B_1 but not by B_2 . If $k = n = 2$, then there is no hole which is enclosed by B_1 but not by B_2 , and there is one hole which is enclosed by B_2 but not by B_1 . By symmetry, we can only prove for the first case.

By Lemma 9.1.1, any positive factorization of $\tau_{B_1}\tau_{B_2}$ is $\tau_{B'_1}\tau_{B'_2}$ up to a global conjugation, where B'_1 and B'_2 enclose the same set of holes as B_1 and B_2 , respectively.

The curves B_1 and B_2 fill the surface \mathbb{D}_4 . Following exactly the same argument we get that B'_1 and B'_2 intersect in exactly 4 points. Now we conjugate $\tau_{B'_1}\tau_{B'_2}$ by a diffeomorphism which takes curve B'_1 to B_1 . This will change $\tau_{B'_1}\tau_{B'_2}$ to $\tau_{B_1}\tau_{B''_2}$, where B''_2 is a curve which encloses the same set of holes as B_2 .

Let γ be an arc connecting holes c_4 and c_0 , see the left of Figure 16. Then, by the proof of Lemma 9.1.3, B''_2 intersects γ in 2 points minimally. We cut the surface \mathbb{D}_4 open along the arc γ , and think of the resulted surface with the outer boundary drawn as a rectangle. See the right of Figure 16. So B''_2 becomes two arcs one of which has two endpoints belong to the left edge and encloses one hole of c_1 and c_3 , and the other of which has two endpoints belong to the right edge and encloses the other hole of c_1 and c_3 .

Exactly as in the proof of Lemma 9.1.3, we get that up to a diffeomorphism preserving orientation and commuting with τ_{B_1} , there are at most two choices for the curve B_2'' . Hence, there are at most two different positive factorizations of $\tau_{B_1}\tau_{B_2}$ up to a global conjugation. \square

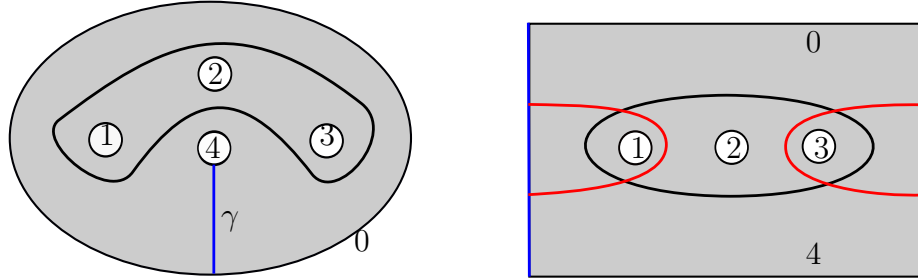

Figure 16: Arc γ along which the surface is cut open is shown in the left picture. The right picture shows the cut open surface.

Lemma 9.1.5. *Let Σ be the surface in Figure 13 with $k = 2$ and $n = 3$. Suppose $p = q = 1$. Then $\tau_{B_1}\tau_{B_2} \in \text{Map}(\mathbb{D}_5, \partial\mathbb{D}_5)$ has at most two positive factorizations up to a global conjugation.*

Proof. Since $k = 2$ and $n = 3$, there is one hole which is enclosed by B_2 but not by B_1 , and one hole which is enclosed by B_1 but not by B_2 .

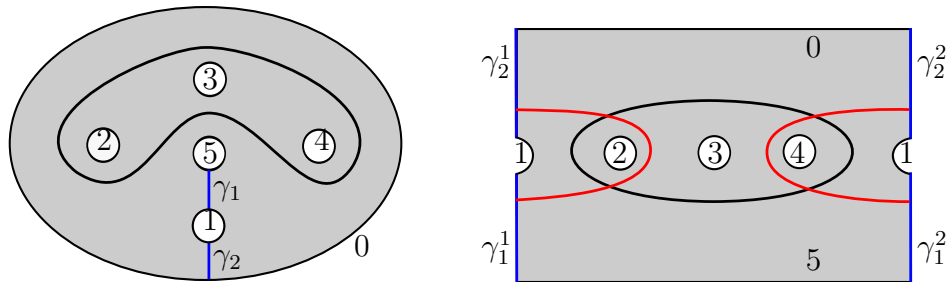

Figure 17: Arcs γ_1 and γ_2 along which the surface is cut open is shown in the left picture. The right picture shows the cut open surface, where γ_i^1 and γ_i^2 are two copies of γ_i , for $i = 1, 2$.

By Lemma 9.1.1, any positive factorization of $\tau_{B_1}\tau_{B_2}$ is $\tau_{B_1'}\tau_{B_2'}$ up to a global conjugation, where B_1' and B_2' enclose the same set of holes as B_1 and B_2 , respectively.

The curves B_1 and B_2 fill the surface \mathbb{D}_5 . Following exactly the same argument as in the proof of Lemma 9.1.3, we get that B'_1 and B'_2 intersect in exactly 4 points. Now we conjugate $\tau_{B'_1}\tau_{B'_2}$ by a diffeomorphism which takes curve B'_1 to B_1 . This will change $\tau_{B'_1}\tau_{B'_2}$ to $\tau_{B_1}\tau_{B''_2}$, where B''_2 is a curve which encloses the same set of holes as B_2 .

If we fill each hole of \mathbb{D}_5 , including the outer boundary, by a disk with a marked point, then we get a 2-sphere with 6 marked points. The two curves B_1 and B''_2 give a cell decomposition of the 2-sphere. It has four vertices, eight edges and six 2-cells. Each 2-cell contains a boundary component of \mathbb{D}_5 . There are four 2-cells which are bigons containing c_0 , c_2 , c_4 , and c_5 , respectively. There are two 2-cells which are squares containing c_1 and c_3 , respectively. Each square has exactly one common edge with each of the four bigons. So there is a properly embedded arc γ'_1 in S which connects holes c_1 and c_5 , has exactly one intersection point with the common edge of the square containing c_1 and the bigon containing c_5 , and is disjoint with B_1 . There is a properly embedded arc γ'_2 in S which connects holes c_1 and c_0 , has exactly one intersection point with the common edge of the square containing c_1 and the bigon containing c_0 , and is disjoint with B_1 . Note that γ'_1 and γ'_2 correspond to two coedges of the cell decomposition. It is easy to make sure that we can choose the arcs γ'_1 and γ'_2 to be disjoint.

There is a diffeomorphism of \mathbb{D}_5 which takes γ'_1 and γ'_2 to γ_1 and γ_2 , respectively, where γ_1 and γ_2 are as shown in the left of Figure 17 and keeps B_1 invariant. Such a diffeomorphism exists because the arcs γ'_1 and γ'_2 chosen are disjoint from the curve B_1 . We denote the image of B''_2 under this diffeomorphism by B''_2 still. Then $I(B''_2, \gamma_i) = 1$ for $i = 1, 2$.

We cut the surface \mathbb{D}_5 open along $\gamma_1 \cup \gamma_2$, and think of the resulted surface with the outer boundary drawn as a rectangle. To avoid confusion with other terminology used, we will denote this cut open surface by \mathcal{R} . See the right of Figure 17. The

curve B_2'' is cut open into two arcs. One of them has both endpoints in the left edge of \mathcal{R} , and the other of them has both endpoints in the right edge of \mathcal{R} . Since B_1 is parallel to the outer boundary of \mathcal{R} , each of the two arcs are either disjoint with B_1 or has exactly two intersection points with B_1 . Since $I(B_1, B_2'') = 4$, both of the two arcs have exactly two intersection points with B_1 . One of them encloses one hole of c_2 and c_4 with a subarc of the left edge of \mathcal{R} . The other of them encloses the other hole of c_2 and c_4 with a subarc of the right edge of \mathcal{R} .

Just as in the proofs of Lemma 9.1.3 and Lemma 9.1.4, we get that there are at most two choices for B_2'' . Hence, $\tau_{B_1}\tau_{B_2}$ has at most two positive factorizations up to a global conjugation. \square

9.1.2 Stein fillings of certain planar open books

Now we go back to the proof of Theorem 9.0.3.

Proof. If $p = q = 1$, then by Lemma 9.1.1, any other positive factorization of Φ must be the product of $\tau_1^{m_1}, \tau_2^{m_2}, \dots, \tau_n^{m_n}, \tau_{n+2}^{m_{n+2}}, \tau_{B_1}'$ and τ_{B_2}' , where curves B_1' and B_2' enclose the same set of holes as curves B_1 and B_2 , respectively. In particular, either $\tau_{B_1}\tau_{B_2} = \tau_{B_1}'\tau_{B_2}'$ or $\tau_{B_1}\tau_{B_2} = \tau_{B_2}'\tau_{B_1}'$. Without loss of generality, we assume that $\tau_{B_1}\tau_{B_2} = \tau_{B_1}'\tau_{B_2}'$.

Suppose a_1, \dots, a_{k-1} are $k-1$ properly embedded pairwise disjoint arcs in Σ which satisfy that: 1) a_i connects the boundary components c_i and c_{i+1} , 2) a_i is disjoint with B_1 and B_2 . Suppose $b_{k+q}, \dots, b_{n+q-2}$ are $n-k-1$ properly embedded pairwise disjoint arcs in Σ which satisfy that: 1) b_i connects the boundary components c_i and c_{i+1} , 2) b_i is disjoint with B_1 and B_2 .

Since the curves B_1 and B_2 do not intersect any of the arcs a_i , the diffeomorphism $\tau_{B_1}\tau_{B_2}$ does not move them. It follows that the diffeomorphism $\tau_{B_1}'\tau_{B_2}'$ does not move any of the arcs a_i as well. We claim that the curves B_1' and B_2' do not intersect any of the arcs a_i . Suppose one of the curves B_1', B_2' did intersect arcs a_i for some

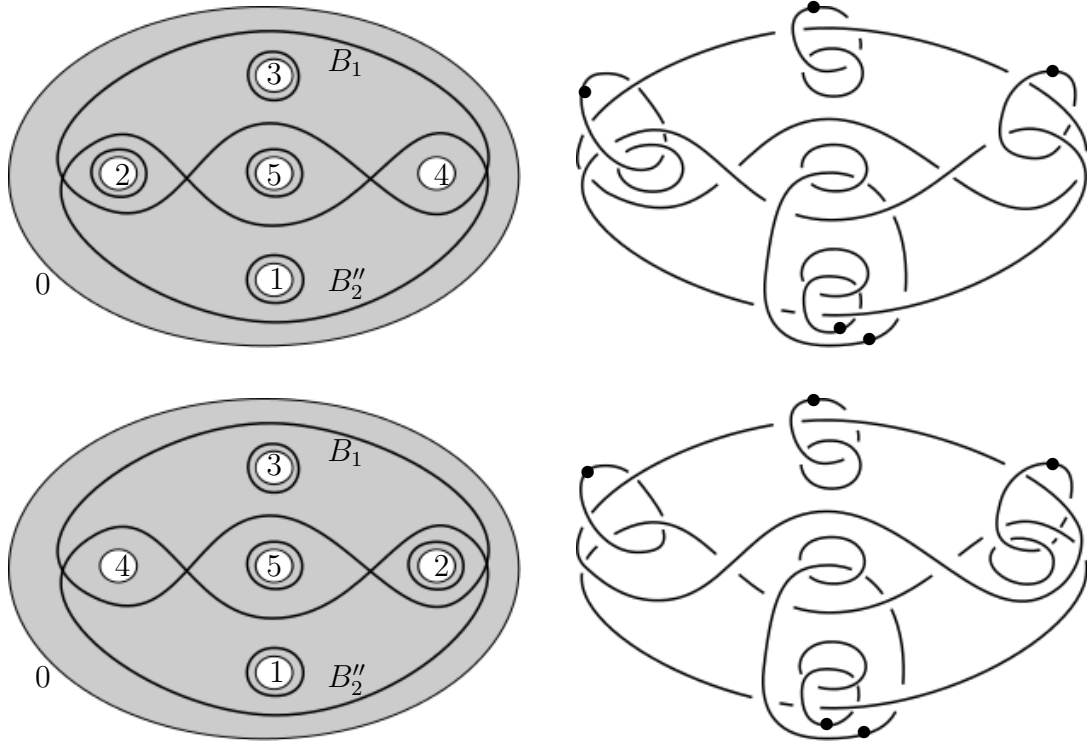

Figure 18: The left two figures indicate the two choices of the curve B_2'' . The upper left figure is $(\Sigma, \tau_1\tau_2\tau_3\tau_5\tau_{B_1}\tau_{B_2''})$. The lower left figure is $(\Sigma, \tau_1\tau_2\tau_3\tau_5\tau_{B_1}\tau_{B_2''})$ which is conjugate to $(\Sigma, \tau_1\tau_2\tau_3\tau_5\tau_{B_2''}\tau_{B_1})$. The right two figures are their corresponding Kirby diagrams for the Stein filling, where each dotted circle is a 4-dimensional 1-handle, and all other circles have surgery coefficients -1 . These two Kirby diagrams denote two diffeomorphic 4-manifolds.

i. Without loss of generality we can assume that curve to be B_2' . In this case, since any positive Dehn twist is right veering(see [43]), the diffeomorphism $\tau_{B_2'}$ will move the arc a_i strictly to the right. Hence, $\tau_{B_1'}$ should move the arc a_i strictly to the left, which is impossible. Similarly, the curves B_1' and B_2' do not intersect any of the arcs b_i .

Since the arcs a_i and b_i are not moved by the diffeomorphism $\tau_{B_1'}\tau_{B_2'}$, we can cut along arcs a_i and b_i . If we do that we are left with the surface \mathbb{D}_3 , \mathbb{D}_4 or \mathbb{D}_5 , depending on k and n . We still denote the curves by B_1, B_2, B_1', B_2' in this new surface. As before, there is a diffeomorphism which sends B_1' to B_1 , and B_2' to B_2'' . Now from Lemmas 9.1.3, 9.1.4 and 9.1.5 it follows that there are at most two factorizations,

up to a global conjugation, of the monodromy given by two different choices for the curve B_2'' .

From the Kirby diagrams, see Figure 18 for an example, we know that for both of these two choices of the curve B_2'' , the manifold supported by the open book decomposition

$$(\Sigma, \tau_1^{m_1} \tau_2^{m_2} \dots \tau_n^{m_n} \tau_{n+2}^{m_{n+2}} \tau_{B_1} \tau_{B_2''})$$

is diffeomorphic to the original oriented 3-manifold, and their corresponding Stein fillings are diffeomorphic. According to Theorem 7.2.17, Theorem 9.0.3 holds in this special case.

Now we are left to prove the general case. Any other factorization of Φ is

$$\tau_1^{m_1} \tau_2^{m_2} \dots \tau_{n+q-1}^{m_{n+q-1}} \tau_{n+q+1}^{m_{n+q+1}} \dots \tau_{n+p+q}^{m_{n+p+q}} \tau_{B_1'} \tau_{B_2'}$$

up to a global conjugation, where B_1' and B_2' enclose the same boundary components as B_1 and B_2 , respectively. In particular, either $\tau_{B_1} \tau_{B_2} = \tau_{B_1'} \tau_{B_2'}$ or $\tau_{B_1} \tau_{B_2} = \tau_{B_2'} \tau_{B_1'}$. Without loss of generality, we assume that $\tau_{B_1} \tau_{B_2} = \tau_{B_1'} \tau_{B_2'}$.

Suppose $u_{n+q+1}, \dots, u_{n+q+p-1}$ are $p-1$ properly embedded pairwise disjoint arcs in Σ which satisfy that: 1) u_i connects the boundary components c_i and c_{i+1} , 2) u_i is disjoint with B_1 and B_2 . Suppose v_k, \dots, v_{k+q-2} are $q-1$ properly embedded pairwise disjoint arcs in Σ which satisfy that: 1) v_i connects the boundary components c_i and c_{i+1} , 2) v_i is disjoint with B_1 and B_2 .

Note that the diffeomorphism $\tau_{B_1} \tau_{B_2}$ does not move any of the arcs $u_{n+q+1}, \dots, u_{n+q+p-1}, v_k, \dots, v_{k+q-2}$ and so $\tau_{B_1'} \tau_{B_2'}$ does not move these arcs either. By the same argument as in previous paragraph, the curves B_1' and B_2' do not intersect arcs $u_{n+q+1}, \dots, u_{n+q+p-1}, v_k, \dots, v_{k+q-2}$.

Hence, to factorize Φ we need to specify curves B_1' and B_2' in the complement of arcs $u_{n+q+1}, \dots, u_{n+q+p-1}, v_k, \dots, v_{k+q-2}$. So, we cut the surface along arcs $u_{n+q+1}, \dots, u_{n+q+p-1}, v_k, \dots, v_{k+q-2}$. Thus we are left with a planar surface with $n+3$ boundary

components. Also, there is a diffeomorphism which sends B'_1 to B_1 , and B'_2 to B''_2 .

By Lemma 9.1.3, Lemma 9.1.4, Lemma 9.1.5, there are at most two factorizations, up to a global conjugation, of the monodromy given by two different choices for the curve B''_2 . Considering the Kirby diagrams, we know that the two Stein fillings are diffeomorphic. This finishes the proof by Theorem 7.2.17. \square

9.1.3 Proofs of the theorems

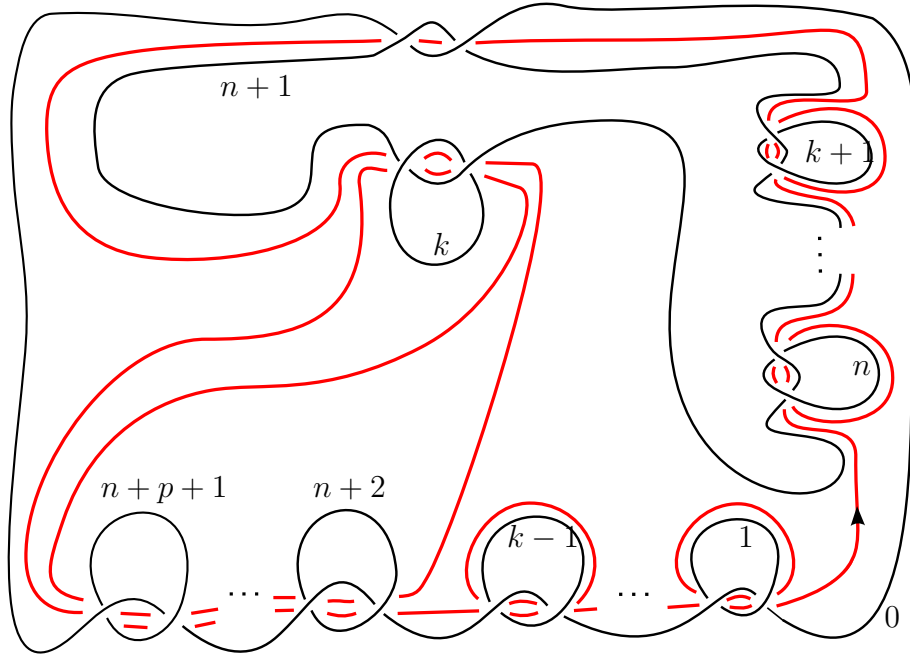

Figure 19: An embedded open book decomposition supporting (S^3, ξ_{std}) with a twist knot K_{-2p} and some unknots on a page.

Proof of Theorem 1.0.6. Let L be a Legendrian twist knot K_{-2p} with Thurston-Bennequin invariant $-n$ and rotation number $n - 2k + 1$. According to [47], we can embed the Legendrian link in Figure 1 into an page of an embedded open book supporting (S^3, ξ_{std}) . See Figure 19.

The embedded open book supporting (S^3, ξ_{std}) can be transformed into an abstract version (Σ, ϕ) with $q = 1$ and

$$\phi = \tau_1 \tau_2 \dots \tau_{k-1} \tau_k \tau_{k+1} \dots \tau_n \tau_{n+2} \dots \tau_{n+p+1} \tau_{B_1}.$$

So the contact structure (M', ξ') is supported by the open book (Σ, Φ) with $q = 1$ and

$$\Phi = \tau_1^{m_1} \tau_2^{m_2} \dots \tau_{k-1}^{m_{k-1}} \tau_k \tau_{k+1}^{m_{k+1}} \dots \tau_n^{m_n} \tau_{n+2} \dots \tau_{n+p+1} \tau_{B_1} \tau_{B_2},$$

where $m_i \geq 1$ for $i = 1, \dots, k-1, k+1, \dots, n$.

By Theorem 9.0.3, (M', ξ') admits a unique Stein filling up to diffeomorphism. \square

Proof of Theorem 1.0.7. The open book

$$(\Sigma, \tau_1 \tau_2 \dots \tau_{n+q-1} \tau_{n+q+1} \dots \tau_{n+p+q} \tau_{B_1})$$

corresponds to (S^3, ξ_{std}) . If we transform it to the embedded version which is similar to Figure 19, then B_2 can be realized as a Legendrian 2-bridge knot $B(p, q)$ topologically shown in Figure 2. It is the result of $n - k$ positive stabilizations and $k - 1$ negative stabilizations of a Legendrian 2-bridge knot $B(p, q)$ with Thurston-Bennequin invariant -1 and rotation number 0 . So by Theorem 9.0.3, the contact 3-manifold which is obtained by Legendrian surgery on (S^3, ξ_{std}) along the Legendrian B_2 admits a unique Stein filling up to diffeomorphism. \square

9.1.4 Uniqueness of certain Stein fillings up to symplectic deformation equivalence

Proof of Theorem 1.0.8. Since L is a Legendrian twist knot K_{-2p} with Thurston-Bennequin invariant -1 and rotation number 0 , according to [47], we can embed $S_+^{n-k} S_-^{k-1}(L)$ into a page of an embedded open book decomposition supporting (S^3, ξ_{std}) as in Figure 19, where the page is a compact planar surface with $n + p + 2$ boundary components. We transform this embedded open book decomposition into an abstract version (Σ, ϕ) with $q = 1$ and

$$\phi = \tau_1 \tau_2 \dots \tau_n \tau_{n+2} \dots \tau_{n+p+1} \tau_{B_1}.$$

The Legendrian surgery on (S^3, ξ_{std}) along the stabilization $S_+^{n-k} S_-^{k-1}(L)$ yields a contact structure ξ_k on the 3-manifold $S_{-1-n}^3(K_{-2p})$, which is supported by the open

book decomposition (Σ, Φ) with $q = 1$ and

$$\Phi = \tau_1 \tau_2 \cdots \tau_n \tau_{n+2} \cdots \tau_{n+p+1} \tau_{B_1} \tau_{B_2}.$$

By Lemma 9.1.1, any positive factorization of Φ has to be the product of $\tau_1, \tau_2, \dots, \tau_n, \tau_{n+2}, \dots, \tau_{n+p+1}, \tau_{B'_1}, \tau_{B'_2}$, where B'_1 and B'_2 enclose the same set of holes as B_1 and B_2 , respectively.

The open book decomposition

$$(\Sigma, \tau_1 \tau_2 \cdots \tau_n \tau_{n+2} \cdots \tau_{n+p+1} \tau_{B'_1})$$

also supports (S^3, ξ_{std}) . We think of B'_2 as a knot in (S^3, ξ_{std}) .

We claim that B'_2 is isotopic to the twist knot K_{-2p} . There is an element $f \in \text{Map}(\Sigma, \partial\Sigma)$ which sends B'_1 to B_1 . We denote $f(B'_2)$ by B''_2 . According to the proof of Theorem 9.0.3, the given monodromy Φ has at most two different positive factorizations, up to a global conjugation, depending on the two choices for B''_2 . Both of the two choices of B''_2 are isotopic to the twist knot K_{-2p} . So B'_2 is isotopic to the twist knot K_{-2p} .

We compute the page framing of B'_2 in the open book decomposition

$$(\Sigma, \tau_1 \tau_2 \cdots \tau_n \tau_{n+2} \cdots \tau_{n+p+1} \tau_{B'_1}).$$

To this end, we compute the linking number of B''_2 and its push-off in the page of open book decomposition

$$(\Sigma, \tau_1 \tau_2 \cdots \tau_n \tau_{n+2} \cdots \tau_{n+p+1} \tau_{B_1})$$

shown in Figure 19. For both of the two choices of B''_2 , it is routine to check that the linking numbers of B''_2 and its push-off in the page are $-n$. So B'_2 has page framing $-n$ with respect to the Seifert framing.

Since B'_2 is not null-homologous in Σ , we can Legendrian realize it. According to the definition of open book decomposition, we know that the Thurston-Bennequin

invariant of B'_2 is the difference between the page framing and the Seifert framing, that is, $-n$.

Therefore, the Lefschetz fibration X over D^2 , with fiber Σ , corresponding to the positive factorization $\tau_1\tau_2\cdots\tau_n\tau_{n+2}\cdots\tau_{n+p+1}\tau_{B'_1}\tau_{B'_2}$ of Φ is diffeomorphic to D^4 , with its standard complex structure, and a 2-handle attached along a $(-1-n)$ -framed twist knot K_{-2p} . Also, X has a Stein structure that arises from the Legendrian surgery along the Legendrian realized B'_2 . By a theorem of Eliashberg [12], we can extend the Stein structure uniquely to this new manifold. Since there is a unique Legendrian twist knot K_{-2p} with Thurston-Bennequin invariant $-n$ and rotation number $n-2k+1$, [18], we know that the only Legendrian twist knot K_{-2p} that can produce $(S^3_{-1-n}(K_{-2p}), \xi_k)$ is $S_+^{n-k}S_-^{k-1}(L)$. This implies that all Stein structures on X are symplectic deformation equivalent. So X has a unique Stein structure up to symplectic deformation.

According to Theorem 7.2.17, every Stein filling of $(S^3_{-1-n}(K_{-2p}), \xi_k)$ is symplectic deformation equivalent to a Lefschetz fibration compatible with the given planar open book decomposition (Σ, Φ) . So there is a unique Stein filling on $(S^3_{-1-n}(K_{-2p}), \xi_k)$, up to symplectic deformation. \square

REFERENCES

- [1] AKBULUT, S. and OZBAGCI, B., “Lefschetz fibrations on compact Stein surfaces,” *Geom. Topol.*, vol. 5, pp. 319–334 (electronic), 2001.
- [2] AKHMEDOV, A., ETNYRE, J. B., MARK, T. E., and SMITH, I., “A note on Stein fillings of contact manifolds,” *Math. Res. Lett.*, vol. 15, no. 6, pp. 1127–1132, 2008.
- [3] BAKER, K. L., ETNYRE, J. B., and VAN HORN-MORRIS, J., “Cabling, contact structures and mapping class monoids,” *J. Differential Geom.*, vol. 90, no. 1, pp. 1–80, 2012.
- [4] BALDWIN, J. A. and ETNYRE, J. B., “Admissible transverse surgery does not preserve tightness,” *Math. Ann.*, vol. 357, no. 2, pp. 441–468, 2013.
- [5] BAYKUR, R. I. and VAN HORN-MORRIS, J., “Families of contact 3-manifolds with arbitrarily large stein fillings.” Submitted.
- [6] BENNEQUIN, D., “Entrelacements et équations de Pfaff,” in *Third Schnepfenried geometry conference, Vol. 1 (Schnepfenried, 1982)*, vol. 107 of *Astérisque*, pp. 87–161, Soc. Math. France, Paris, 1983.
- [7] BOWDEN, J., “Exactly fillable contact structures without Stein fillings,” *Algebr. Geom. Topol.*, vol. 12, no. 3, pp. 1803–1810, 2012.
- [8] DING, F. and GEIGES, H., “Symplectic fillability of tight contact structures on torus bundles,” *Algebr. Geom. Topol.*, vol. 1, pp. 153–172 (electronic), 2001.

- [9] DING, F. and GEIGES, H., “A Legendrian surgery presentation of contact 3-manifolds,” *Math. Proc. Cambridge Philos. Soc.*, vol. 136, no. 3, pp. 583–598, 2004.
- [10] ELIASHBERG, Y., “Classification of overtwisted contact structures on 3-manifolds,” *Invent. Math.*, vol. 98, no. 3, pp. 623–637, 1989.
- [11] ELIASHBERG, Y., “Filling by holomorphic discs and its applications,” in *Geometry of low-dimensional manifolds, 2 (Durham, 1989)*, vol. 151 of *London Math. Soc. Lecture Note Ser.*, pp. 45–67, Cambridge Univ. Press, Cambridge, 1990.
- [12] ELIASHBERG, Y., “Topological characterization of Stein manifolds of dimension > 2 ,” *Internat. J. Math.*, vol. 1, no. 1, pp. 29–46, 1990.
- [13] ELIASHBERG, Y., “Contact 3-manifolds twenty years since J. Martinet’s work,” *Ann. Inst. Fourier (Grenoble)*, vol. 42, no. 1-2, pp. 165–192, 1992.
- [14] ELIASHBERG, Y., “A few remarks about symplectic filling,” *Geom. Topol.*, vol. 8, pp. 277–293, 2004.
- [15] ELIASHBERG, Y. M. and THURSTON, W. P., *Confoliations*, vol. 13 of *University Lecture Series*. American Mathematical Society, Providence, RI, 1998.
- [16] ELIASHBERG, Y., “Unique holomorphically fillable contact structure on the 3-torus,” *Internat. Math. Res. Notices*, no. 2, pp. 77–82, 1996.
- [17] ENDO, H. and NAGAMI, S., “Signature of relations in mapping class groups and non-holomorphic Lefschetz fibrations,” *Trans. Amer. Math. Soc.*, vol. 357, no. 8, pp. 3179–3199, 2005.
- [18] ETNYRE, J., NG, L., and VÉRTESI, V., “Legendrian and transverse twist knots,” *J. Eur. Math. Soc. (JEMS)*, vol. 15, no. 3, pp. 969–995, 2013.

- [19] ETNYRE, J. B., “Symplectic convexity in low-dimensional topology,” *Topology Appl.*, vol. 88, no. 1-2, pp. 3–25, 1998. Symplectic, contact and low-dimensional topology (Athens, GA, 1996).
- [20] ETNYRE, J. B., “Planar open book decompositions and contact structures,” *Int. Math. Res. Not.*, no. 79, pp. 4255–4267, 2004.
- [21] ETNYRE, J. B., “Legendrian and transversal knots,” in *Handbook of knot theory*, pp. 105–185, Elsevier B. V., Amsterdam, 2005.
- [22] ETNYRE, J. B., “Lectures on open book decompositions and contact structures,” in *Floer homology, gauge theory, and low-dimensional topology*, vol. 5 of *Clay Math. Proc.*, pp. 103–141, Providence, RI: Amer. Math. Soc., 2006.
- [23] ETNYRE, J. B. and HONDA, K., “Knots and contact geometry. I. Torus knots and the figure eight knot,” *J. Symplectic Geom.*, vol. 1, no. 1, pp. 63–120, 2001.
- [24] ETNYRE, J. B. and HONDA, K., “On the nonexistence of tight contact structures,” *Ann. of Math. (2)*, vol. 153, no. 3, pp. 749–766, 2001.
- [25] ETNYRE, J. B. and HONDA, K., “Tight contact structures with no symplectic fillings,” *Invent. Math.*, vol. 148, no. 3, pp. 609–626, 2002.
- [26] FARB, B. and MARGALIT, D., *A primer on mapping class groups*, vol. 49 of *Princeton Mathematical Series*. Princeton, NJ: Princeton University Press, 2012.
- [27] FATHI, A., LAUDENBACH, F., and POÉNARU, V., *Thurston’s work on surfaces*, vol. 48 of *Mathematical Notes*. Princeton University Press, Princeton, NJ, 2012. Translated from the 1979 French original by Djun M. Kim and Dan Margalit.
- [28] FUCHS, D. and TABACHNIKOV, S., “Invariants of Legendrian and transverse knots in the standard contact space,” *Topology*, vol. 36, no. 5, pp. 1025–1053, 1997.

- [29] GAY, D. and MARK, T. E., “Convex plumbings and Lefschetz fibrations,” *J. Symplectic Geom.*, vol. 11, no. 3, pp. 363–375, 2013.
- [30] GEIGES, H., “Examples of symplectic 4-manifolds with disconnected boundary of contact type,” *Bull. London Math. Soc.*, vol. 27, no. 3, pp. 278–280, 1995.
- [31] GEIGES, H., *An introduction to contact topology*, vol. 109 of *Cambridge Studies in Advanced Mathematics*. Cambridge: Cambridge University Press, 2008.
- [32] GHIGGINI, P., “Strongly fillable contact 3-manifolds without Stein fillings,” *Geom. Topol.*, vol. 9, pp. 1677–1687 (electronic), 2005.
- [33] GHIGGINI, P., “Tight contact structures on Seifert manifolds over T^2 with one singular fibre,” *Algebr. Geom. Topol.*, vol. 5, pp. 785–833, 2005.
- [34] GHIGGINI, P., LISCA, P., and STIPSICZ, A. I., “Classification of tight contact structures on small Seifert 3-manifolds with $e_0 \geq 0$,” *Proc. Amer. Math. Soc.*, vol. 134, no. 3, pp. 909–916 (electronic), 2006.
- [35] GIROUX, E., “Structures de contact en dimension trois et bifurcations des feuilletages de surfaces,” *Invent. Math.*, vol. 141, no. 3, pp. 615–689, 2000.
- [36] GOMPF, R. E., “Handlebody construction of Stein surfaces,” *Ann. of Math. (2)*, vol. 148, no. 2, pp. 619–693, 1998.
- [37] GOMPF, R. E. and STIPSICZ, A. I., *4-manifolds and Kirby calculus*, vol. 20 of *Graduate Studies in Mathematics*. Providence, RI: American Mathematical Society, 1999.
- [38] GRAUERT, H., “On Levi’s problem and the imbedding of real-analytic manifolds,” *Ann. of Math. (2)*, vol. 68, pp. 460–472, 1958.
- [39] GROMOV, M., “Pseudoholomorphic curves in symplectic manifolds,” *Invent. Math.*, vol. 82, no. 2, pp. 307–347, 1985.

- [40] HAMIDI-TEHRANI, H., “Groups generated by positive multi-twists and the fake lantern problem,” *Algebr. Geom. Topol.*, vol. 2, pp. 1155–1178 (electronic), 2002.
- [41] HIND, R., “Stein fillings of lens spaces,” *Commun. Contemp. Math.*, vol. 5, no. 6, pp. 967–982, 2003.
- [42] HONDA, K., “On the classification of tight contact structures. I,” *Geom. Topol.*, vol. 4, pp. 309–368, 2000.
- [43] HONDA, K., KAZEZ, W. H., and MATIĆ, G., “Right-veering diffeomorphisms of compact surfaces with boundary,” *Invent. Math.*, vol. 169, no. 2, pp. 427–449, 2007.
- [44] KALOTI, A. and LI, Y., “Stein fillings of contact 3-manifolds obtained as Legendrian surgeries.” Submitted.
- [45] KANDA, Y., “The classification of tight contact structures on the 3-torus,” *Comm. Anal. Geom.*, vol. 5, no. 3, pp. 413–438, 1997.
- [46] KANDA, Y., “On the Thurston-Bennequin invariant of Legendrian knots and nonexactness of Bennequin’s inequality,” *Invent. Math.*, vol. 133, no. 2, pp. 227–242, 1998.
- [47] LI, Y. and WANG, J., “The support genera of certain Legendrian knots,” *J. Knot Theory Ramifications*, vol. 21, no. 11, pp. 1250105, 8, 2012.
- [48] LICKORISH, W. B. R., “A representation of orientable combinatorial 3-manifolds,” *Ann. of Math. (2)*, vol. 76, pp. 531–540, 1962.
- [49] LISCA, P., “On symplectic fillings of 3-manifolds,” in *Proceedings of 6th Gökova Geometry-Topology Conference*, vol. 23, pp. 151–159, 1999.
- [50] LISCA, P., “On symplectic fillings of lens spaces,” *Trans. Amer. Math. Soc.*, vol. 360, no. 2, pp. 765–799 (electronic), 2008.

- [51] LISCA, P. and STIPSICZ, A. I., “Ozsváth-Szabó invariants and tight contact three-manifolds. II,” *J. Differential Geom.*, vol. 75, no. 1, pp. 109–141, 2007.
- [52] LISCA, P. and STIPSICZ, A. I., “On the existence of tight contact structures on Seifert fibered 3-manifolds,” *Duke Math. J.*, vol. 148, no. 2, pp. 175–209, 2009.
- [53] LISI, S., VAN HORN-MORRIS, J., and WENDL, C., “On symplectic fillings of spinal open book decomposition.” preprint in preparation.
- [54] LOI, A. and PIERGALLINI, R., “Compact Stein surfaces with boundary as branched covers of B^4 ,” *Invent. Math.*, vol. 143, no. 2, pp. 325–348, 2001.
- [55] MARGALIT, D., “A lantern lemma,” *Algebr. Geom. Topol.*, vol. 2, pp. 1179–1195 (electronic), 2002.
- [56] MARGALIT, D. and MCCAMMOND, J., “Geometric presentations for the pure braid group,” *J. Knot Theory Ramifications*, vol. 18, no. 1, pp. 1–20, 2009.
- [57] MARTINET, J., “Formes de contact sur les variétés de dimension 3,” in *Proceedings of Liverpool Singularities Symposium, II (1969/1970)*, pp. 142–163. Lecture Notes in Math., Vol. 209, Springer, Berlin, 1971.
- [58] MASSOT, P., “Infinitely many universally tight torsion free contact structures with vanishing Ozsváth-Szabó contact invariants,” *Math. Ann.*, vol. 353, no. 4, pp. 1351–1376, 2012.
- [59] MCDUFF, D., “The structure of rational and ruled symplectic 4-manifolds,” *J. Amer. Math. Soc.*, vol. 3, no. 3, pp. 679–712, 1990.
- [60] MCDUFF, D., “Symplectic manifolds with contact type boundaries,” *Invent. Math.*, vol. 103, no. 3, pp. 651–671, 1991.

- [61] MCDUFF, D. and SALAMON, D., *Introduction to symplectic topology*. Oxford Mathematical Monographs, The Clarendon Press, Oxford University Press, New York, 1995. Oxford Science Publications.
- [62] NIEDERKRÜGER, K. and WENDL, C., “Weak symplectic fillings and holomorphic curves,” *Ann. Sci. Éc. Norm. Supér. (4)*, vol. 44, no. 5, pp. 801–853, 2011.
- [63] OHTA, H. and ONO, K., “Simple singularities and symplectic fillings,” *J. Differential Geom.*, vol. 69, no. 1, pp. 1–42, 2005.
- [64] PLAMENEVSKAYA, O., “Contact structures with distinct Heegaard Floer invariants,” *Math. Res. Lett.*, vol. 11, no. 4, pp. 547–561, 2004.
- [65] PLAMENEVSKAYA, O., “On Legendrian surgeries between lens spaces,” *J. Symplectic Geom.*, vol. 10, no. 2, pp. 165–181, 2012.
- [66] PLAMENEVSKAYA, O. and VAN HORN-MORRIS, J., “Planar open books, monodromy factorizations and symplectic fillings,” *Geom. Topol.*, vol. 14, no. 4, pp. 2077–2101, 2010.
- [67] STARKSTON, L., “Symplectic fillings of seifert fibered spaces.” Submitted.
- [68] STIPSICZ, A. I., “Gauge theory and Stein fillings of certain 3-manifolds,” *Turkish J. Math.*, vol. 26, no. 1, pp. 115–130, 2002.
- [69] STIPSICZ, A. I., “On the geography of Stein fillings of certain 3-manifolds,” *Michigan Math. J.*, vol. 51, no. 2, pp. 327–337, 2003.
- [70] THURSTON, W. P. and WINKELNKEMPER, H. E., “On the existence of contact forms,” *Proc. Amer. Math. Soc.*, vol. 52, pp. 345–347, 1975.
- [71] THURSTON, W. P., “Three-dimensional manifolds, Kleinian groups and hyperbolic geometry,” *Bull. Amer. Math. Soc. (N.S.)*, vol. 6, no. 3, pp. 357–381, 1982.

- [72] WAJNRYB, B., “An elementary approach to the mapping class group of a surface,” *Geom. Topol.*, vol. 3, pp. 405–466 (electronic), 1999.
- [73] WALLACE, A. H., “Modifications and cobounding manifolds,” *Canad. J. Math.*, vol. 12, pp. 503–528, 1960.
- [74] WAND, A., “Factorizations of diffeomorphisms of compact surfaces with boundary.” Submitted.
- [75] WAND, A., “Mapping class group relations, Stein fillings, and planar open book decompositions,” *J. Topol.*, vol. 5, no. 1, pp. 1–14, 2012.
- [76] WEINSTEIN, A., “On the hypotheses of Rabinowitz’ periodic orbit theorems,” *J. Differential Equations*, vol. 33, no. 3, pp. 353–358, 1979.
- [77] WEINSTEIN, A., “Contact surgery and symplectic handlebodies,” *Hokkaido Math. J.*, vol. 20, no. 2, pp. 241–251, 1991.
- [78] WENDL, C., “Strongly fillable contact manifolds and J -holomorphic foliations,” *Duke Math. J.*, vol. 151, no. 3, pp. 337–384, 2010.
- [79] WENDL, C., “A hierarchy of local symplectic filling obstructions for contact 3-manifolds,” *Duke Math. J.*, vol. 162, no. 12, pp. 2197–2283, 2013.
- [80] WU, H., “Legendrian vertical circles in small Seifert spaces,” *Commun. Contemp. Math.*, vol. 8, no. 2, pp. 219–246, 2006.

INDEX