

LEGENDRIAN KNOTS AND OPEN BOOK DECOMPOSITIONS

A THESIS SUBMITTED TO
THE GRADUATE SCHOOL OF NATURAL AND APPLIED SCIENCES
OF
MIDDLE EAST TECHNICAL UNIVERSITY

BY

SİNEM ÇELİK ONARAN

IN PARTIAL FULFILLMENT OF THE REQUIREMENTS
FOR
THE DEGREE OF DOCTOR OF PHILOSOPHY
IN
MATHEMATICS

JULY 2009

Approval of the thesis:

LEGENDRIAN KNOTS AND OPEN BOOK DECOMPOSITIONS

submitted by **SİNEM ÇELİK ONARAN** in partial fulfillment of the requirements for the degree of **Doctor of Philosophy in Mathematics Department, Middle East Technical University** by,

Prof. Dr. Canan Özgen

Dean, Graduate School of **Natural and Applied Sciences**

Prof. Dr. Zafer Nurlu

Head of Department, **Mathematics**

Prof. Dr. Mustafa Korkmaz

Supervisor, **Department of Mathematics, METU**

Prof. Dr. John B. Etnyre

Co-supervisor, **School of Mathematics, Georgia Institute of Technology**

Examining Committee Members:

Prof. Dr. Yıldırım Ozan

Department of Mathematics, METU

Prof. Dr. Mustafa Korkmaz

Department of Mathematics, METU

Assoc. Prof. Dr. Tolga Eteü

Department of Mathematics, Koç University

Assoc. Prof. Dr. Burak Özbaęcı

Department of Mathematics, Koç University

Prof. Dr. Sinan Sertöz

Department of Mathematics, Bilkent University

Date:

July 9th, 2009

I hereby declare that all information in this document has been obtained and presented in accordance with academic rules and ethical conduct. I also declare that, as required by these rules and conduct, I have fully cited and referenced all material and results that are not original to this work.

Name, Last Name: SİNEM ÇELİK ONARAN

Signature :

ABSTRACT

LEGENDRIAN KNOTS AND OPEN BOOK DECOMPOSITIONS

Çelik Onaran, Sinem

Ph.D., Department of Mathematics

Supervisor : Prof. Dr. Mustafa Korkmaz

Co-Supervisor : Prof. Dr. John B. Etnyre

July 2009, 46 pages

In this thesis, we define a new invariant of a Legendrian knot in a contact manifold using an open book decomposition supporting the contact structure. We define the support genus $sg(L)$ of a Legendrian knot L in a contact 3-manifold (M, ξ) as the minimal genus of a page of an open book of M supporting the contact structure ξ such that L sits on a page and the framings given by the contact structure and the page agree. For any topological link in S^3 we construct a planar open book decomposition whose monodromy is a product of positive Dehn twists such that the planar open book contains the link on its page. Using this, we show any topological link, in particular any knot in any 3-manifold M sits on a page of a planar open book decomposition of M and we show any null-homologous loose Legendrian knot in an overtwisted contact structure has support genus zero.

Keywords: contact structures, Legendrian knots, open book decompositions

ÖZ

LEGENDRIAN DÜĞÜMLER VE AÇIK KİTAPLAR

Çelik Onaran, Sinem

Doktora, Matematik Bölümü

Tez Yöneticisi : Prof. Dr. Mustafa Korkmaz

Ortak Tez Yöneticisi : Prof. Dr. John B. Etnyre

Temmuz 2009, 46 sayfa

Bu tezde, kontakt yapıları destekleyen açık kitapları kullanarak kontakt çokkatlılar içindeki Legendrian düğümler için yeni değişmezler tanımladık. Kontakt 3-boyutlu çokkatlı (M, ξ) içindeki bir Legendrian L düğümünün $sg(L)$ ile gösterdiğimiz cinsini, kontakt yapı ξ 'yi destekleyen, L 'yi bir sayfasında içeren ve sayfasının L 'ye verdiği çatı kontakt çatıya eşit olan açık kitapların sayfa cinslerinin en küçüğü olarak tanımladık. S^3 içinde verilen her topolojik link için monodromisi pozitif Dehn burgularından oluşan ve verilen linki sayfasında içeren düzlemsel açık kitaplar oluşturduk. Bu sonucu kullanarak, 3-boyutlu her çokkatlı içindeki her linkin çokkatlının düzlemsel bir açık kitabının bir sayfası içinde kalacağını kanıtladık. Ayrıca, aşırı dönen kontakt yapılar içinde homolojisi sıfır olan her gevşek Legendrian düğümün cinsinin sıfır olduğunu gösterdik.

Anahtar Kelimeler: kontakt yapılar, Legendrian düğümler, açık kitaplar

To my family

ACKNOWLEDGMENTS

I would like to express my heartfelt gratitude to my co-advisor John B. Etnyre. I learned how research is done from him and I am still learning. I would like to thank him for his guidance, his patience and for the time he spent for my improvement in research.

I thank to my advisor Mustafa Korkmaz for his motivations and for valuable comments. I am thankful to Kenneth Lee Baker, Stavros Garoufalidis, Çağrı Karakurt and Burak Özbağcı for helpful suggestions and for inspiring conversations.

I wish to thank to my colleagues and my friends Derya Altıntan, Elif Yılmaz Dalyan, Amey Kaloti, Elif Medetoğulları, Sergio Angel Almada Monter, Öznür Özdemir and Bülent Tosun for their lovely friendship.

I would like to thank to my family for providing me the best of everything and for being my side in difficult times.

My special thanks to my husband Suphi Server Onaran for his endless love, for his generous support from ∞ -miles away and for his encouragement to go forward all the time.

The financial support of The Scientific and Technical Research Council of Turkey (TÜBİTAK) and the financial support from John B. Etnyre's NSF grant is also gratefully acknowledged.

TABLE OF CONTENTS

ABSTRACT	iv
ÖZ	v
DEDICATION	vi
ACKNOWLEDGMENTS	vii
TABLE OF CONTENTS	viii
LIST OF FIGURES	x
CHAPTERS	
1 INTRODUCTION	1
2 BACKGROUND	3
2.1 Contact Structures	3
2.2 Legendrian Knots	6
2.3 Open Book Decompositions	9
3 TOPOLOGICAL LINKS AND OPEN BOOK DECOMPOSITIONS	16
3.1 Pure braided plat of Links	16
3.2 Knots and Links in 3-sphere	19
3.3 Knots and Links in 3-manifolds	29
4 LEGENDRIAN KNOTS AND OPEN BOOK DECOMPOSITIONS	34
4.1 Support Genus of Legendrian Knots	34
4.2 Legendrian Knots in overtwisted contact structures	35
4.2.1 Loose Legendrian Knots	35
4.2.2 Non-loose Legendrian Knots	37

4.3	Legendrian Knots in tight contact structures	39
4.4	Legendrian Knots in contact structures	40
	REFERENCES	42
	VITA	44

LIST OF FIGURES

FIGURES

Figure 2.1 (a) The standard tight contact structure on \mathbb{R}^3 , (b) An overtwisted contact structure on \mathbb{R}^3	4
Figure 2.2 Legendrian Trefoil knot.	7
Figure 2.3 The positive stabilization $S_+(L)$ and the negative stabilization $S_-(L)$ of L . . .	7
Figure 2.4 A bypass for L and $L' = S_{\pm}(L)$. The curve Γ is the dividing curve of D	9
Figure 2.5 (a) The open book decomposition compatible with the standard tight contact structure on S^3 , (b) The open book decomposition compatible with the standard overtwisted contact structure on S^3	11
Figure 2.6 (a) Positive stabilization $S_+(L)$ of L , (b) Negative stabilization $S_-(L)$ of L , (c) Positive destabilization of L' , $S_+(L'_+) = L'$, (d) Negative destabilization of L' , $S_-(L'_-) = L'$	12
Figure 2.7 (a) Positive stabilization $L_+ = S_+(L)$ of L , (b) Negative stabilization $L_- = S_-(L)$ of L	13
Figure 2.8 (c) Positive destabilization of L' , $S_+(L'_+) = L'$, (d) Negative destabilization of L' , $S_-(L'_-) = L'$	14
Figure 3.1 Shifted $2n$ -plat of the link L	17
Figure 3.2 From a shifted $2n$ -plat to a pure braided plat.	17
Figure 3.3 Pure braided plat.	18
Figure 3.4 Braid representative of the figure eight knot.	19
Figure 3.5 Pure braided plat presentation of the figure eight knot.	20

Figure 3.6	Unknotting the figure eight knot.	21
Figure 3.7	The unknotted knot K bounds a disk.	22
Figure 3.8	Page of a planar open book decomposition containing the figure eight knot, pages are disk with 16 punctures.	23
Figure 3.9	Generator A_{ij} for the pure braid group.	24
Figure 3.10	Different ways of blowing up to remove twists.	24
Figure 3.11	Generators: $A_{ii+1}, A_{i+1,j+1}, A_{ij+1}, A_{i+1,j}, A_{ij}$	26
Figure 3.12	Case (2) $A_{i+1,j+1}$	26
Figure 3.13	Generators: $A_{ii+1}, A_{i+1,j+1}, A_{ij+1}, A_{i+1,j}, A_{ij}$	27
Figure 3.14	Inverses: $A_{ii+1}^{-1}, A_{i+1,j+1}^{-1}, A_{ij+1}^{-1}, A_{i+1,j}^{-1}, A_{ij}^{-1}$	27
Figure 3.15	Construct the page of the open book by taking connected sum of the com- ponents L_1, \dots, L_k of the link L	28
Figure 3.16	Resolving the cases (2) $A_{i+1,j+1}^{-1}$ and (3) A_{ij+1}^{-1} in such a way that the cases contribute only positive Dehn twists to monodromy.	29
Figure 3.17	Other than 0-framed knots each remaining case contains only -1 -framed knots.	30
Figure 3.18	± 1 -surgery on a link L_M of n unknots giving the 3-manifold M	31
Figure 3.19	Surgery on a Borromean link giving the Poincaré homology sphere.	32
Figure 3.20	Pure braid representation of Borromean link and a way of resolving the twists.	32
Figure 3.21	A planar open book for the Poincaré homology sphere, the monodromy φ is $\varphi = t_\beta^{-1} t_\alpha^{-1} t_\beta t_\alpha t_{\delta_1}^{-1} t_{\delta_2} t_{\delta_3}^{-1}$	33
Figure 4.1	Legendrian unknot L , $tb(L) = -1$, $rot(L) = 0$, $sg(L) = 0$	35
Figure 4.2	Legendrian Torus knots.	37
Figure 4.3	$(p, pn + 1)$ Torus knots.	38

CHAPTER 1

INTRODUCTION

One of the most striking results of contact geometry is a theorem of Giroux which gives a characterization of contact 3-manifolds in terms of open book decompositions. Giroux has shown that there is a one to one correspondence between isotopy classes of contact structures on a closed orientable 3-manifold M and suitable equivalence classes of open book decompositions of M , [20]. This result allows us to treat contact structures as topological objects. In another direction, one may study Legendrian knots to study contact structures. Legendrian knots is important in contact geometry since they reveal the geometry and topology of the underlying 3-manifold. For example, Legendrian knots are used to distinguish contact structures [24], to detect topological properties of knots [34] and to detect overtwistedness of contact structures [14]. In this thesis, we study Legendrian knots in contact 3-manifolds using open book decompositions. We first study the topological properties of knots sitting on pages of open book decompositions and then we study the contact geometric properties of knots sitting on pages of open book decompositions.

In Chapter 2, we give a review of background information on contact structures, Legendrian knots in contact manifolds and open book decompositions.

In Chapter 3, for a given topological link in S^3 we present an explicit algorithm to construct a planar open book decomposition whose monodromy is a product of positive Dehn twists and contains the given link on its page. Using this, we prove a general property for topological links, in particular for knots. We prove that any topological link in a closed, orientable 3-manifold sits on a planar page of an open book decomposition. It is well known that, [2], every closed orientable 3-manifold has an open book decomposition; in fact has a planar open book decomposition, [33]. Different ways of constructing open book decompositions for 3-manifolds are known for a long time. Alternatively, using the ideas for constructing planar open

books for knots and links we construct explicit planar open books for any closed orientable 3-manifolds.

In [16], given any contact 3-manifold, Etnyre and Ozbagci defined new invariants of contact structures in terms of open book decompositions supporting the contact structure. One of the invariants is the support genus of the contact structure which is defined as the minimal genus of a page of an open book that supports the contact structure. In a similar fashion, we define the support genus $sg(L)$ of a Legendrian knot L in a contact 3-manifold (M, ξ) as the minimal genus of a page of an open book of M supporting the contact structure ξ such that L sits on a page and the framings of L given by the contact structure and the page agree. This definition is originally due to Etnyre.

In the last chapter, we show any null-homologous loose Legendrian knot in an overtwisted contact 3-manifold has support genus $sg(L) = 0$. We construct examples of non-loose Legendrian knots having support genus zero or non-zero. We list several observations related to Legendrian knots in contact 3-manifolds. We observe that for any given knot type K in (S^3, ξ_{std}) , there is a Legendrian representative L of K such that $sg(L) = 0$. We show the existence of Legendrian knots with non-zero support genus in weakly fillable contact structures. Moreover, we observe that for a non-zero rational number $r \in \mathbb{Q}$, any contact 3-manifold which is obtained by a contact r -surgery on a support genus zero Legendrian knot has support genus zero.

CHAPTER 2

BACKGROUND

In this chapter we review the basics of contact geometry. In Section 2.1, we define contact structures and give some examples that will be used throughout the thesis. Section 2.2 discusses Legendrian knots in contact 3-manifolds. Finally, in Section 2.3, we define open book decompositions and we discuss the relation between open book decompositions of 3-manifolds and contact structures.

2.1 Contact Structures

Contact structures on odd dimensional manifolds are very natural objects. We restrict ourselves to contact structures on 3-manifolds. For more information see [10], [19], [31].

Definition 2.1.1. A *contact structure* ξ on an oriented 3-manifold M is a maximally non-integrable 2-plane field.

The non-integrability condition implies that ξ is not everywhere tangent to any surface. Locally there is a 1-form α such that $\xi = \ker \alpha$ and $\alpha \wedge d\alpha \neq 0$. If ξ is orientable, in this case 1-form α exists globally and the 1-form α is called a *contact form*. We denote a *contact 3-manifold* as (M, ξ) .

Definition 2.1.2. Two contact manifolds (M_1, ξ_1) and (M_2, ξ_2) are *contactomorphic* if there is a diffeomorphism $\psi : M_1 \rightarrow M_2$ such that $\psi_*(\xi_1) = \xi_2$. Two contact structures ξ_1 and ξ_2 on a 3-manifold M are *isotopic* if there is a contactomorphism $\psi : (M, \xi_1) \rightarrow (M, \xi_2)$ such that ψ is isotopic to the identity.

There are two types of contact structures on 3-manifolds, tight and overtwisted.

Definition 2.1.3. A contact structure ξ on M is *overtwisted* if it contains an overtwisted disk, that is, an embedded disk D in M such that ∂D is tangent to ξ and the contact framing of ∂D coincides with the framing given by the disk D . If ξ does not contain an overtwisted disk, then ξ is called *tight*.

Example 2.1.4. Let $\alpha = dz - ydx$ in Cartesian coordinates. The contact structure $\xi_{std} = \ker\alpha$ is the standard tight contact structure on \mathbb{R}^3 . Note that $\alpha \wedge d\alpha = dx \wedge dy \wedge dz \neq 0$ and ξ is spanned by $\{\frac{\partial}{\partial y}, \frac{\partial}{\partial x} + y\frac{\partial}{\partial z}\}$. See Figure 2.1(a). Also, consider $\alpha = \cos r dz - r \sin r d\theta$ in \mathbb{R}^3 with cylindrical coordinates. The contact structure $\xi_{ot} = \ker\alpha$ is an overtwisted contact structure on \mathbb{R}^3 . Note that in this case $\alpha \wedge d\alpha = (1 + \frac{\sin r \cos r}{r})r dr \wedge d\theta \wedge dz \neq 0$ and for $r \neq 0$ ξ_{ot} is spanned by $\{\frac{\partial}{\partial r}, \cos r \frac{\partial}{\partial \theta} - r \sin r \frac{\partial}{\partial z}\}$. See Figure 2.1(b).

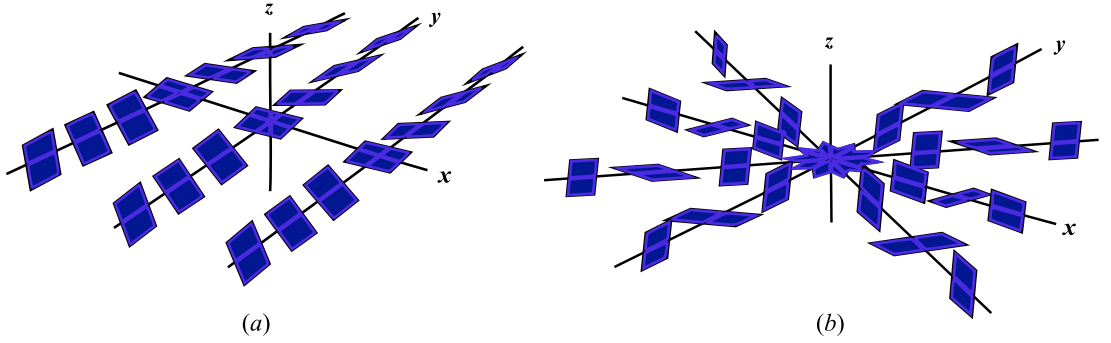

Figure 2.1: (a) The standard tight contact structure on \mathbb{R}^3 , (b) An overtwisted contact structure on \mathbb{R}^3 .

All contact structures look the same near a point.

Theorem 2.1.5 (Darboux's theorem). *For a given contact 3-manifold (M, ξ) and a point $x \in M$, there is a neighborhood U of x in M such that $(U, \xi|_U)$ is contactomorphic to $(V, \xi_{std}|_V)$ for some open set V in $(\mathbb{R}^3, \xi_{std})$.*

Example 2.1.6. The standard tight contact structure ξ_{std} on the 3-sphere S^3 in \mathbb{R}^4 is given by the kernel of the 1-form $\alpha = x_1 dy_1 - y_1 dx_1 + x_2 dy_2 - y_2 dx_2|_{S^3}$ with Cartesian coordinates (x_1, y_1, x_2, y_2) in \mathbb{R}^4 . Note the standard tight contact structure on S^3 with one point removed is contactomorphic to the standard tight contact structure on \mathbb{R}^3 , see [19] for an explicit contactomorphism.

Example 2.1.7. The standard overtwisted contact structure ξ_{ot} on S^3 is obtained from ξ_{std} by performing a simple Lutz twist along a transverse knot in (S^3, ξ_{std}) . A transverse knot T in a

contact 3-manifold (M, ξ) is a knot which is everywhere transverse to the contact planes. A simple Lutz twist along a transverse knot T is an operation replacing the contact structure on a tubular neighborhood $S^1 \times D^2$ of T with a contact structure ξ' given by the kernel of the 1-form $\beta = h_1(r)d\theta + h_2(r)d\varphi$ where θ is the S^1 coordinate and (r, φ) are the polar coordinates on D^2 and $h_1, h_2 : [0, 1] \rightarrow \mathbb{R}$ smooth functions satisfying:

1. $h_1 = -1, h_2 = -r^2$ near $r = 0$,
2. $h_1 = 1, h_2 = r^2$ near $r = 1$,
3. (h_1, h_2) is never parallel to (h'_1, h'_2) when $r \neq 0$,
4. (h_1, h_2) does not intersect the positive y axis.

Note that a simple Lutz twist results in an overtwisted contact 3-manifold and in general it changes the homotopy type of the contact structure.

Theorem 2.1.8 (Eliashberg, [9]). *Two overtwisted contact structures are isotopic if and only if they are homotopic as oriented 2-plane fields. Moreover, every homotopy class of oriented 2-plane fields contains an overtwisted contact structure.*

In general, for two oriented 2-plane fields to be homotopic we have:

Theorem 2.1.9 (Gompf, [21]). *Two oriented 2-plane fields are homotopic if and only if their 2-dimensional invariants d_2 and 3-dimensional invariants d_3 are equal.*

For the notation we use here for the 2-dimensional invariants d_2 and the 3-dimensional invariants d_3 , see [19]. Notice that we can regard a contact structure ξ on a 3-manifold M as a complex line bundle and in this way we can consider its first Chern class $c_1(\xi) \in H^2(M, \mathbb{Z})$. The 2-dimensional invariant d_2 is determined by the spin^c structure associated to ξ and if $H^2(M, \mathbb{Z})$ has no 2-torsion then d_2 is also determined by $c_1(\xi)$. If (X, J) is an almost complex 4-manifold with $\partial X = M$, then the almost complex structure J naturally induces a 2-plane field on M by taking the complex tangencies of J along ∂X . If $c_1(\xi)$ is torsion then the 3-dimensional invariant $d_3(\xi)$ can be computed as

$$d_3(\xi) = \frac{1}{4}(c_1^2(X, J) - 3(\sigma(X)) - 2\chi(X))$$

where X is an almost complex 4-manifold with $\partial X = M$ such that the oriented 2-plane field induced by complex tangencies is homotopic to the contact structure ξ on M . Here, $\sigma(X)$

denotes the signature of X and $\chi(X)$ denotes the Euler characteristic of X . For the computation of $c_1^2(X, J)$ see [21], [6].

Finally, we recall the fillability of contact structures. A contact 3-manifold (M, ξ) is called *weakly symplectically fillable* if M is the oriented boundary of a symplectic manifold (X, ω) such that $\omega|_{\xi} > 0$.

Theorem 2.1.10 (Eliashberg [8], Gromov [22]). *Any weakly symplectically fillable contact 3-manifold (M, ξ) is tight.*

2.2 Legendrian Knots

Legendrian and transverse knots are very natural objects in contact 3-manifolds and they play an important role in the theory. For more information see [12].

Definition 2.2.1. A knot L in a contact 3-manifold (M, ξ) is called *Legendrian* if it is everywhere tangent to ξ , that is, $T_x L \in \xi_x$ for all $x \in L$.

There are two types of Legendrian knots in overtwisted contact structures, loose and non-loose.

Definition 2.2.2. A Legendrian knot in an overtwisted contact 3-manifold M is called *loose* if its complement is also overtwisted. We call a Legendrian knot *non-loose* if its complement is tight.

The classical invariants of Legendrian knots are the topological knot type, the Thurston-Bennequin invariant $tb(L)$ and the rotation number $rot(L)$. *The Thurston-Bennequin invariant $tb(L)$* measures the framing of L given by the contact planes with respect to the framing given by the Seifert surface of L . *The rotation number $rot(L)$* of an oriented null-homologous Legendrian knot L can be computed as the winding number of TL after trivializing ξ along a Seifert surface for L .

Let L be a Legendrian knot in \mathbb{R}^3 with its standard contact structure ξ_{std} given by kernel of the 1-form $\alpha = dz - ydx$. The *front projection* of L is the image of L , $\pi(L)$, under the map $\pi : \mathbb{R}^3 \rightarrow \mathbb{R}^2 : (x, y, z) \mapsto (x, z)$. Using front projections, one can compute the Thurston-Bennequin invariant $tb(L)$, and the rotation number $rot(L)$ of a Legendrian knot L by using the

following formulas:

$$tb(L) = \text{writhe}(L) - \frac{1}{2}(\#cups),$$

$$rot(L) = \frac{1}{2}(\#down\ cusp - \#up\ cusp).$$

where the writhe of L is the sum of the signs of the crossings of L .

Example 2.2.3. In Figure 2.2 we show a front diagram of a Legendrian trefoil knot with $tb(L) = 1$ and $rot(L) = 0$. Notice that, the front projection has no vertical tangencies, instead there are cusps. In addition, at a crossing the strand with a smaller slope lies in front of the strand with a larger slope.

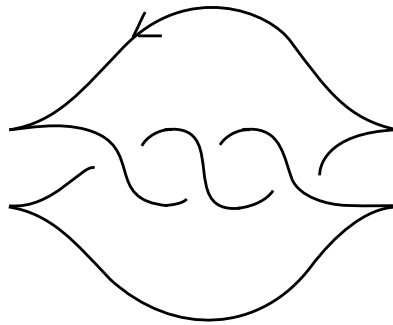

Figure 2.2: Legendrian Trefoil knot.

Definition 2.2.4. *The positive stabilization $S_+(L)$ and the negative stabilization $S_-(L)$ of a Legendrian knot L in the standard contact structure ξ_{std} on \mathbb{R}^3 is obtained by modifying the front projection of L by adding a down cusp and an up cusp as in Figure 2.3, respectively.*

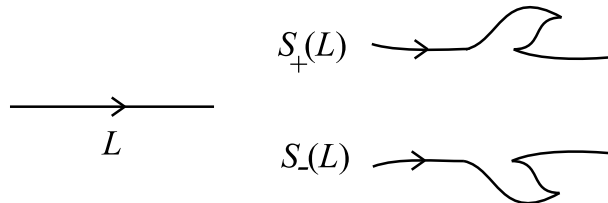

Figure 2.3: The positive stabilization $S_+(L)$ and the negative stabilization $S_-(L)$ of L .

Since stabilizations are done locally, by Darboux's theorem this defines stabilizations of Legendrian knots in any contact 3-manifold (M, ξ) . After stabilizing a Legendrian knot the classical invariants change as $tb(S_{\pm}(L)) = tb(L) - 1$ and $rot(S_{\pm}(L)) = rot(L) \pm 1$.

By looking at the characteristic foliation we may see how to destabilize a Legendrian knot. The **characteristic foliation** Σ_{ξ} is the singular foliation induced on Σ from ξ where $\Sigma_{\xi}(p) = \xi_p \cap T\Sigma_p$, $p \in \Sigma$. The singular points are the points where $\xi_p = T\Sigma_p$. Any surface Σ may be perturbed so that its characteristic foliation Σ_{ξ} has only generic isolated singularities, elliptic singularities and hyperbolic singularities. The singularity is positive if the orientation on ξ_p agrees with the orientation of $T\Sigma_p$. If the orientation on ξ_p disagrees with the orientation of $T\Sigma_p$, then the singularity is negative.

Recall that a closed oriented surface Σ in a contact manifold (M, ξ) is called **convex** if there is a **contact vector field** \mathbf{v} , that is a vector field whose flow preserves the contact structure ξ , transverse to Σ . Given a convex surface Σ in (M, ξ) with a contact vector field \mathbf{v} , the **dividing set** Γ_{Σ} of Σ is defined as

$$\Gamma_{\Sigma} = \{x \in \Sigma : \mathbf{v}(x) \in \xi_x\}.$$

The dividing set Γ_{Σ} is a multi curve, that is a properly embedded smooth 1-manifold, possibly disconnected and possibly with boundary. The isotopy class of Γ_{Σ} does not depend on the choice of the contact vector field \mathbf{v} .

A properly embedded curve C on a convex surface Σ is **non-isolating** if C is transverse to Γ_{Σ} and every component of $\Sigma - (\Gamma_{\Sigma} \cup C)$ intersects Γ_{Σ} . The next theorem gives a criteria to determine whether a given curve or a collection of disjoint curves on a convex surface Σ can be made Legendrian.

Theorem 2.2.5 (Legendrian Realization Principle, [25], [23]). *If C is a properly embedded non-isolating curve on a convex surface Σ then C can be made Legendrian, that is there exists an isotopy ϕ_s of Σ , $s \in [0, 1]$, such that $\phi_0 = id|_{\Sigma}$, $\phi_s(\Sigma)$ is convex for all s , $\phi_1(\Gamma_{\Sigma}) = \Gamma_{\phi_1(\Sigma)}$ and $\phi_1(C)$ is Legendrian.*

Given an oriented Legendrian knot L , the positive stabilization $S_+(L)$ of L and the Legendrian knot L cobound a convex disk D where $tb(\partial D) = -1$ and $D \cap L$ contains two negative elliptic and one negative hyperbolic singularities and $D \cap S_+(L)$ contains the same two negative elliptic singularities and one positive elliptic singularity. Similarly, the negative stabilization $S_-(L)$ of L and the Legendrian knot L cobound a convex disk D where $tb(\partial D) = -1$ and $D \cap L$ contains

two positive elliptic and one positive hyperbolic singularities and $D \cap S_-(L)$ contains the same two positive elliptic singularities and one negative elliptic singularity. Such a disk is called a *stabilizing disk* for L or a *bypass* for L and $S_\pm(L)$. See Figure 2.4. Note that all the singularities of D_ξ have the same sign except one which indicate us whether we are positively or negatively stabilizing the Legendrian knot L . For a detailed discussion of stabilizations and bypass disks see [12], [15].

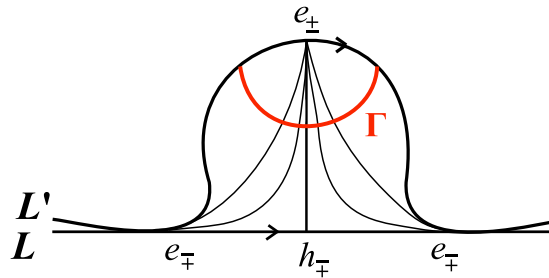

Figure 2.4: A bypass for L and $L' = S_\pm(L)$. The curve Γ is the dividing curve of D .

2.3 Open Book Decompositions

Alexander proved that every closed orientable 3-manifold has an open book decomposition, [2]. Thus open book decompositions provide us another way of studying 3-manifold topology.

Definition 2.3.1. An *open book decomposition* of a closed, oriented 3-manifold M is a triple (B, S, π) where B is an oriented link in M and π is a fibration of the complement $M - B$ over the circle whose fibers are the interior of Seifert surfaces of B . The link B is called the *binding* and the fiber surface S is called the *page* of the open book decomposition.

The *genus* of an open book decomposition is defined as the genus of the page. In particular, planar open book decompositions are genus zero open book decompositions.

An alternative definition of an open book decomposition can be given as follows:

Definition 2.3.2. An *abstract open book decomposition* of a closed, oriented 3-manifold M is a pair (S, φ) where S is an oriented compact surface with boundary link B and φ is a diffeomor-

phism of S such that φ is identity on a neighborhood of the boundary ∂S and

$$M - B = S \times [0, 1] / (1, x) \sim (0, \varphi(x)).$$

The map φ is called the *monodromy* of the open book decomposition.

Definition 2.3.3. *Positive stabilization* of an open book decomposition (S, φ) is the open book decomposition $(S', \varphi \circ t_a^{+1})$ where $S' = S \cup (1\text{-handle})$ and t_a is a right handed Dehn twist along the closed curve a in S' running over the 1-handle and intersecting the co-core of the 1-handle once. Instead of a right handed twist t_a if we use a left handed twist t_a^{-1} along the closed curve a in S' then the resulting open book decomposition $(S', \varphi \circ t_a^{-1})$ is called a *negative stabilization* of (S, φ) .

Definition 2.3.4. An open book decomposition of M and a contact structure ξ on M are *compatible* if after an isotopy of the contact structure, there is a contact form α for ξ such that $\alpha > 0$ on the binding B , in other words the binding B is a positive transverse link, and $d\alpha > 0$ on every page of the open book decomposition.

Example 2.3.5. Consider the open book decomposition $(A, \varphi = t_\alpha)$ of S^3 where the binding H^+ is the positive Hopf link, the page A is an annulus and the monodromy φ is a right-handed Dehn twist along the middle curve α . The open book decomposition $(A, \varphi = t_\alpha)$ is compatible with the standard tight contact structure ξ_{std} on S^3 . See Figure 2.5(a).

Also, consider the open book decomposition $(A, \varphi = t_\alpha^{-1})$ of S^3 where the binding H^- is the negative Hopf link, the page A is an annulus and the monodromy φ is a left-handed Dehn twist along the middle curve α . The open book decomposition $(A, \varphi = t_\alpha^{-1})$ is compatible with the standard overtwisted contact structure ξ_{ot} on S^3 . See Figure 2.5(b).

Open book decompositions and contact structures are closely related. An open book decomposition of a 3-manifold M naturally gives rise to a contact structure on M and the isotopy classes of contact structures are in one to one correspondence with suitable equivalence classes of open book decompositions of M .

Theorem 2.3.6 (Thurston and Winkelnkemper [36]). *Every open book decomposition of a 3-manifold admits a compatible contact structure.*

Theorem 2.3.7 (Giroux, [20]). *Every contact structure is compatible with some open book decomposition and there is a one to one correspondence between oriented contact structures up to isotopy and open book decompositions up to positive stabilization.*

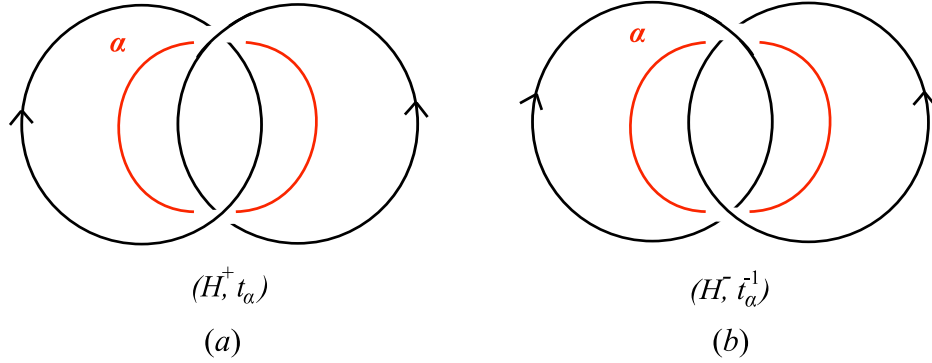

Figure 2.5: (a) The open book decomposition compatible with the standard tight contact structure on S^3 , (b) The open book decomposition compatible with the standard overtwisted contact structure on S^3 .

The plumbing of open book decompositions is a special case of a more general operation called Murasugi sum which is a method for constructing manifolds with open book decompositions.

Definition 2.3.8. Let (S_1, φ_1) and (S_2, φ_2) be open book decompositions for M_1 and M_2 , respectively. The **plumbing** of open books (S_1, φ_1) and (S_2, φ_2) is an open book decomposition $(S_1 * S_2, \varphi_1 \circ \varphi_2)$ for the connected sum $M_1 \# M_2$ where the pages $S_1 * S_2$ is obtained by gluing S_1 to S_2 along a rectangular neighborhood $R_i = s_i \times [-1, 1]$ of properly embedded arcs s_i in $S_i, i = 1, 2$.

Theorem 2.3.9 (Gabai [18], Torisu [37]). *Let (S_1, φ_1) and (S_2, φ_2) be open book decompositions compatible with the contact 3-manifolds (M_1, ξ_1) and (M_2, ξ_2) , respectively. Then, the plumbing $(S_1 * S_2, \varphi_1 \circ \varphi_2)$ of the open books (S_1, φ_1) and (S_2, φ_2) is compatible with the contact 3-manifold $(M_1 \# M_2, \xi_1 \# \xi_2)$.*

The next lemma is useful and gives the relation between the stabilizations of open book decompositions and the stabilizations of Legendrian knots sitting on a page of an open book decomposition.

Lemma 2.3.10. *Let (S, φ) be an open book decomposition for a closed oriented 3-manifold M compatible with a contact structure ξ on M . Let L be a Legendrian knot sitting on a page of the open book.*

- (I) *Positive (resp. negative) stabilization $S_+(L)$ (resp. $S_-(L)$) of the Legendrian knot L can be realized on the page of the open book by first stabilizing the open book positively and*

then pushing the knot L over the 1-handle that we use to stabilize the open book. See Figure 2.6(a) and (b).

- (2) If we first negatively stabilize the open book and then push the knot L over the 1-handle that we use to stabilize the open book, then the negatively stabilized open book is no longer compatible with the contact structure ξ , but the curve L on the page gives a Legendrian knot L' in the new contact structure and Legendrian knots L'_+ and L'_- in Figure 2.6(c) and (d) are positive and negative destabilizations of L' , respectively.

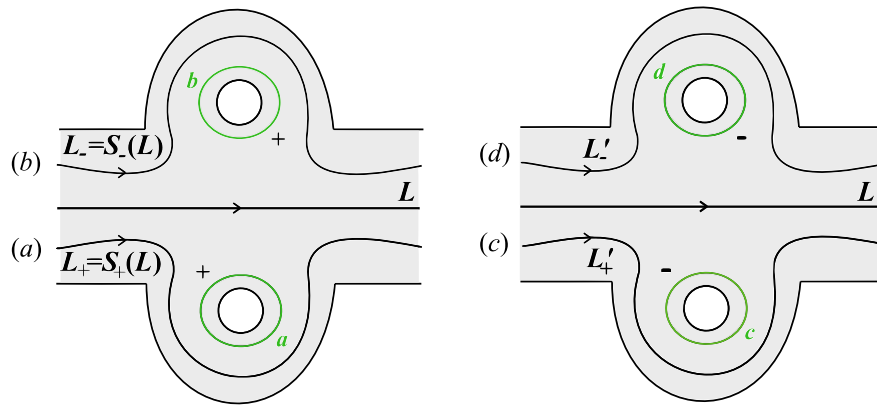

Figure 2.6: (a) Positive stabilization $S_+(L)$ of L , (b) Negative stabilization $S_-(L)$ of L , (c) Positive destabilization of L' , $S_+(L'_+) = L'$, (d) Negative destabilization of L' , $S_-(L'_-) = L'$.

Proof. (I) To prove (1) we find a stabilizing disk for each case as we discussed in previous Section 2.2. See Figure 2.4. First, positively stabilize the open book as in Figure 2.6(a) and push the Legendrian knot L over the 1-handle that is used to stabilize the open book positively, call the new curve L_+ . We will show that L_+ is a positive stabilization $S_+(L)$ of L .

Notice the Legendrian unknot a with $tb(a) = -1$ in Figure 2.6(a). Legendrian unknot a bounds a disk D in M . Since $tb(a) = -1$, D is convex and the dividing curves intersect ∂D twice. Now, we can think L_+ as the knot obtained from pushing L across D . Note that D is a bypass for L and L_+ . See Figure 2.7(a), the curve Γ denotes the diving curve of D . A singularity along ∂D is positive or negative depending on whether the contact planes passing D are twisting in a right handed fashion or a left handed fashion. The sign of the singularities is determined by using the orientation of L which determines the orientation of D near the boundary. See Figure 2.7(a) again.

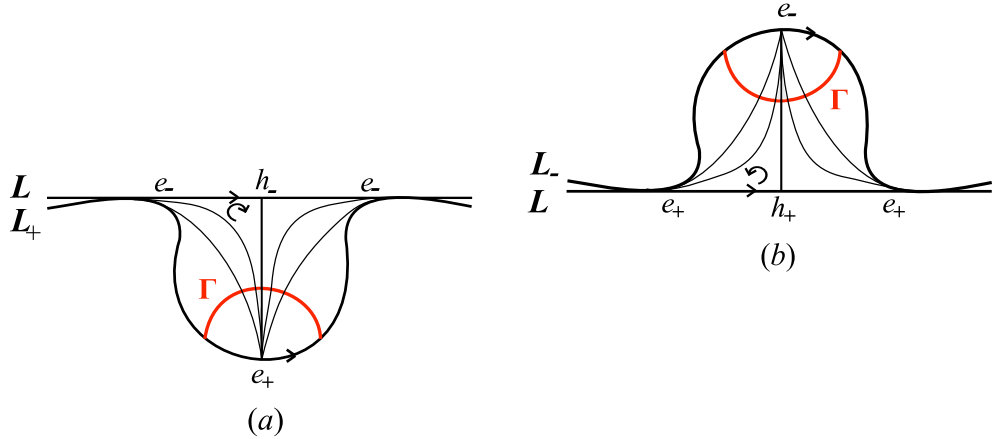

Figure 2.7: (a) Positive stabilization $L_+ = S_+(L)$ of L , (b) Negative stabilization $L_- = S_-(L)$ of L .

The negative stabilization $S_-(L)$ of the Legendrian knot L can be realized on a page of the open book decomposition in a similar way. This time we use the Legendrian unknot b with $tb(b) = -1$ in Figure 2.6(b) and the convex disk that b bounds in M . See Figure 2.7(b).

(2) We prove (2) for null-homologous Legendrian knots only. First, negatively stabilize the open book as in Figure 2.6(c) and then push the knot L over the 1-handle that is used to stabilize the open book negatively, call the new curve L'_+ .

Note that in general the negative stabilization of an open book decomposition changes the contact structure ξ . However, in this case the curve L on the page gives a Legendrian knot L' in the new contact structure. We will show that L'_+ in Figure 2.6(c) is a positive destabilization of L' .

We want to remark that the Legendrian unknot c with $tb(c) = +1$ in Figure 2.6(c) bounds a disk D in M . Since D is not convex unlike in the proof of (1) we can not use this disk to find a bypass. Instead, we positively stabilize the open book as in Figure 2.8(c) and push the Legendrian knot L'_+ over the 1-handle that we use to stabilize the open book positively. By (1), the resulting Legendrian knot is a positive stabilization $S_+(L'_+)$ of L'_+ . We will show that $S_+(L'_+)$ is Legendrian isotopic to L' . Note that the curve α in Figure 2.8(c) is a Legendrian unknot with $tb(\alpha) = 0$. In fact, Legendrian unknot α bounds an overtwisted disk which is disjoint from L'_+ in M . Legendrian knots L' and $S_+(L'_+)$ have the same classical invariants, that is, they have the same knot type, same Thurston-Bennequin invariant and same rotation

number, and since they have a common overtwisted disk in their complement by [7], L' and $S_+(L'_+)$ are Legendrian isotopic.

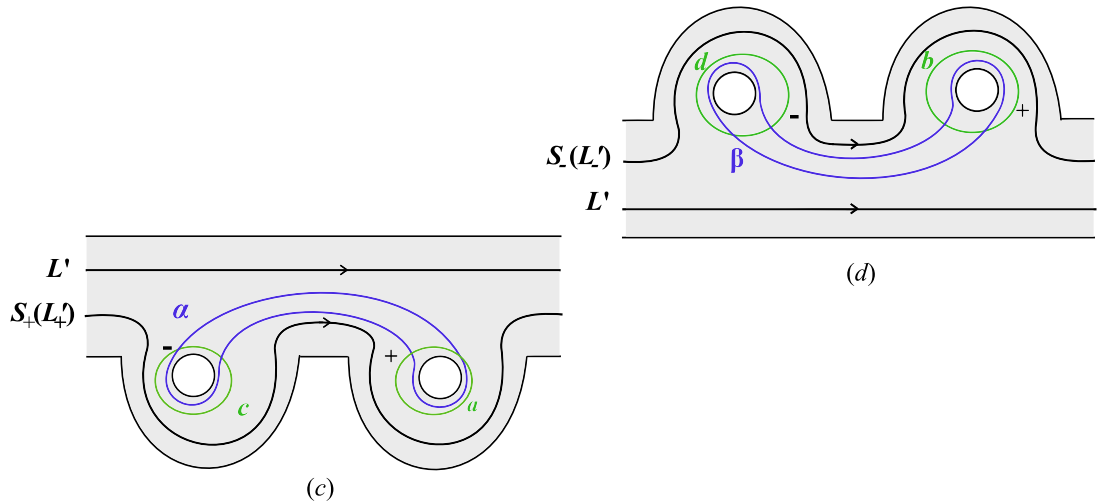

Figure 2.8: (c) Positive destabilization of L' , $S_+(L'_+) = L'$, (d) Negative destabilization of L' , $S_-(L'_-) = L'$.

Similarly, the negative destabilization L'_- of the Legendrian knot L' can be realized on a page of the open book decomposition. We stabilize the open book as in Figure 2.8(d) and push the Legendrian knot L'_- over the 1-handle to get negative stabilization $S_-(L'_-)$ of L'_- . We conclude that $S_-(L'_-)$ and L' are Legendrian isotopic by using the Legendrian unknot β in Figure 2.8(d).

■

We also use the following lemma later.

Lemma 2.3.11. *Let M be a closed oriented 3-manifold and let (S, φ) be an open book decomposition for M .*

- (I) *If K is a knot in M intersecting each page S transversely once, then the result of a 0-surgery along K gives a new manifold with an open book decomposition having a page $S' = S - \{\text{open disk}\}$ and having the knot K as one of the binding components. In particular, if the knot $K = \{x\} \times [0, 1] / \sim$ in the mapping torus $M_\varphi = M - B$ in M for a fixed point $x \in S$ of φ and if $\varphi|_{\{\text{open disk}\}} = \text{id}$ then the new monodromy φ' after a 0-surgery along K is $\varphi' = \varphi|_{S'}$.*

(2) *If K is a knot in M sitting on a page S of the open book decomposition, then ± 1 -surgery along K with respect to the page framing gives a new manifold with an open book decomposition $(B, S, \varphi \circ t_K^{\mp 1})$ where t_K^{+1}/t_K^{-1} denotes right/left handed Dehn twists along the knot K .*

A proof of above Lemma 2.3.11 and more information on open book decompositions and contact structures can be found in [13].

CHAPTER 3

TOPOLOGICAL LINKS AND OPEN BOOK DECOMPOSITIONS

In this chapter, we study the topological properties of links sitting on the pages of open book decompositions. In the following section, we define some terminology and we state a fundamental lemma that we use to prove the main theorems. In Section 3.2, we study links on pages of open book decompositions of S^3 . Finally, in the last section, we study links on pages of open book decompositions of arbitrary 3-manifolds.

3.1 Pure braided plat of Links

It is well known that any link L of k components L_1, \dots, L_k , in particular any knot K , can be represented as a $2n$ -plat, see Figure 3.1(a), [4].

Definition 3.1.1. The shifted $2n$ -plat of the link L of k components L_1, \dots, L_k is defined as the closure of a $2n$ -braid as shown in Figure 3.1(b). We say a shifted $2n$ -plat of the link L is pure braided $2n$ -plat if its associated $2n$ -braid is a pure braid.

To prove the main theorems, we need the following lemma.

Lemma 3.1.2. (1) *Every knot can be represented as a pure braided plat.*

(2) *Every link of k components L_1, \dots, L_k can be represented as a pure braided plat.*

Proof. (1) We may isotope a shifted $2n$ -plat of the knot K to get a pure braided $2n$ -plat for K as follows: First orient the knot K and label the lower and the upper end points of the strands

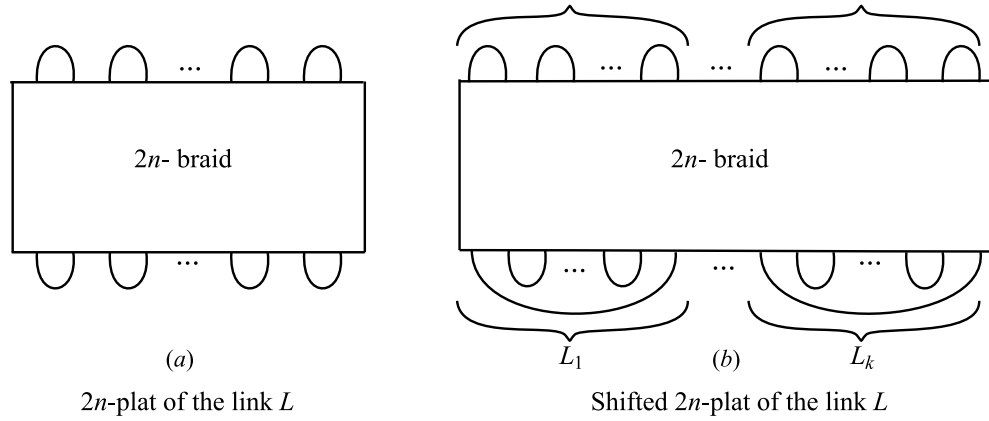

Figure 3.1: Shifted $2n$ -plat of the link L .

of associated $2n$ -braid b and pair them as in Figure 3.2. We have the following list of pairs: for the lower end points $(2n, 1), (2, 3), \dots, (2n - 2, 2n - 1)$ and for the upper end points $(1', 2'), \dots, ((2n - 1)', (2n)')$. Also, denote the permutation in the permutation group S_{2n} on the set $\{1, \dots, 2n\}$ associated to $2n$ -braid b of the shifted $2n$ -plat by σ .

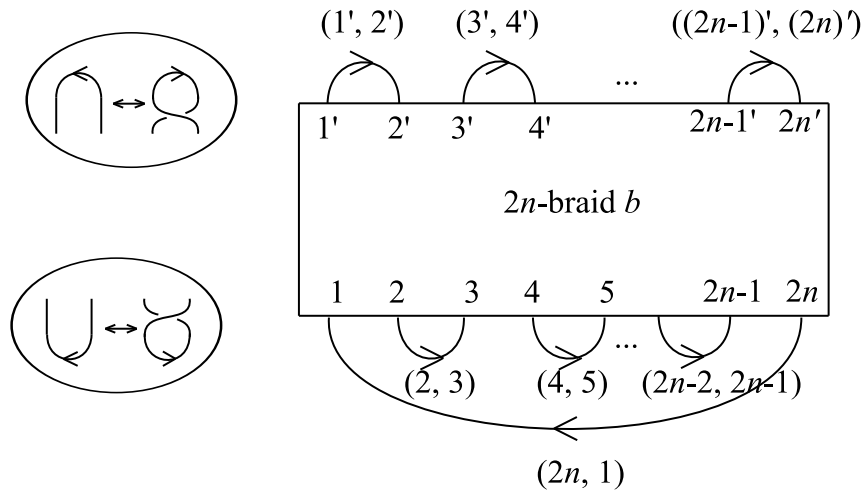

Figure 3.2: From a shifted $2n$ -plat to a pure braided plat.

Now, start in the lower left strand with a labeled 1 lower end point. This strand connects to its upper point $j' = \sigma(1)$. Isotope $(j', (j + 1)')$ to the left as in Figure 3.3(a) so that the first

labeled upper point at the top is $j' = \sigma(1)$. Now relabel upper end points as $1', 2', \dots, (2n)'$ and without loss of generality denote the permutation associated to new $2n$ -braid as σ again. Next, find where the strand whose upper end point is $2'$ connects at the bottom, its lower end point will be $\sigma^{-1}(2') = k$ where k is an element from the set $\{2, \dots, 2n - 1\}$. Note that $k \neq 2n$, otherwise the knot K would be a link. Isotope $(k, k + 1)$ to the left as in Figure 3.3(b) to be the second labeled strand at the bottom. Relabel the lower end points as $1, 2, \dots, 2n$ and without loss of generality denote the permutation associated to new $2n$ -braid as σ again. Note that we have $\sigma(1) = 1', \sigma(2') = 2$. Find $\sigma(3)$ and isotope similarly to be the third labeled strand at the top. Continuing in this manner, we will obtain a pure braid giving a pure braided $2n$ -plat of the knot K .

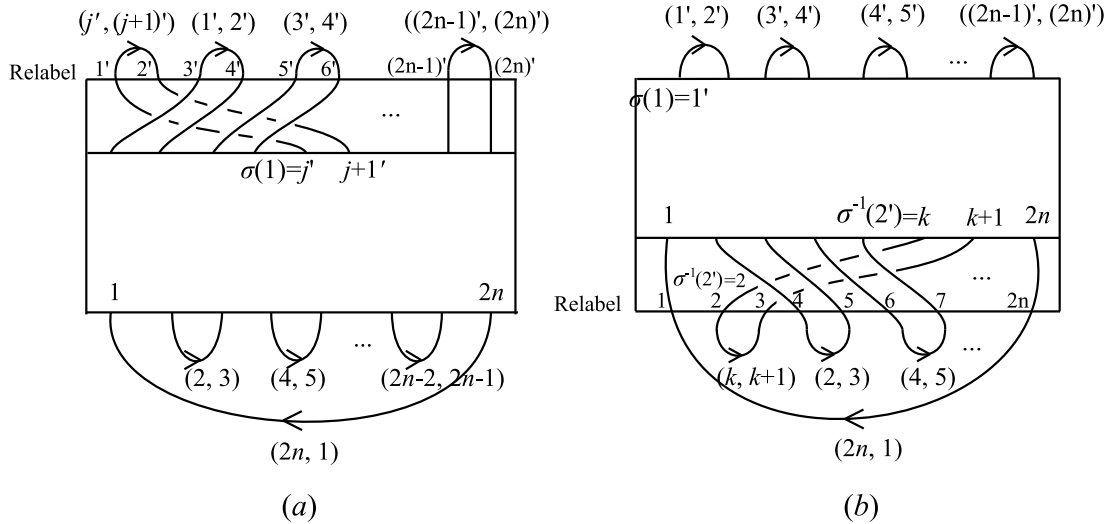

Figure 3.3: Pure braided plat.

(2) First of all, given a link L of k components L_1, \dots, L_k we can present the link L as a plat. From this plat we can obtain a shifted $2n$ -plat of L such that it has the same form as in Figure 3.1(b) with an associated braid b which is not necessarily a pure braid. However, the algorithm described in proof of (1) extends to convert a shifted $2n$ -plat of L into a pure braided $2n$ -plat. ■

3.2 Knots and Links in 3-sphere

Theorem 3.2.1. *Any knot K in S^3 is planar, that is, K sits on a page of a planar open book decomposition for S^3 .*

Before the proof of Theorem 3.2.1, let us give an illustrative example. The proof will follow exactly the same scheme.

Example 3.2.2. The figure eight knot K is planar. The aim here is to present the figure eight knot K as a pure braided plat as in Figure 3.6(a) and using this pure braided plat and the ideas in Lemma 2.3.11 to construct a planar open book which contains the figure eight knot on its page.

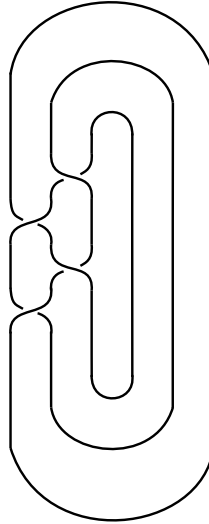

Figure 3.4: Braid representative of the figure eight knot.

We start with a minimum braid representation of the figure eight knot K as in Figure 3.4. Throughout this example σ_i , $i = 1, \dots, n - 1$, stand for the standard generators of the braid group B_n on n -strands. Note that K has braid index 3 and its associated braid word is $b = \sigma_2^{-1}\sigma_1\sigma_2^{-1}\sigma_1$. As seen in Figure 3.5(a), we can represent K by a 6-plat associated to a 6-braid $b_0\tilde{b}b_0^{-1}$ where $b_0 = (\sigma_2\sigma_3\sigma_4\sigma_5)(\sigma_3\sigma_4)$ and \tilde{b} is the 6-braid obtained from b by adding 3 trivially braided strands.

Now isotope the diagram in Figure 3.5(a) to obtain a shifted 6-plat as in Figure 3.5(b) and using

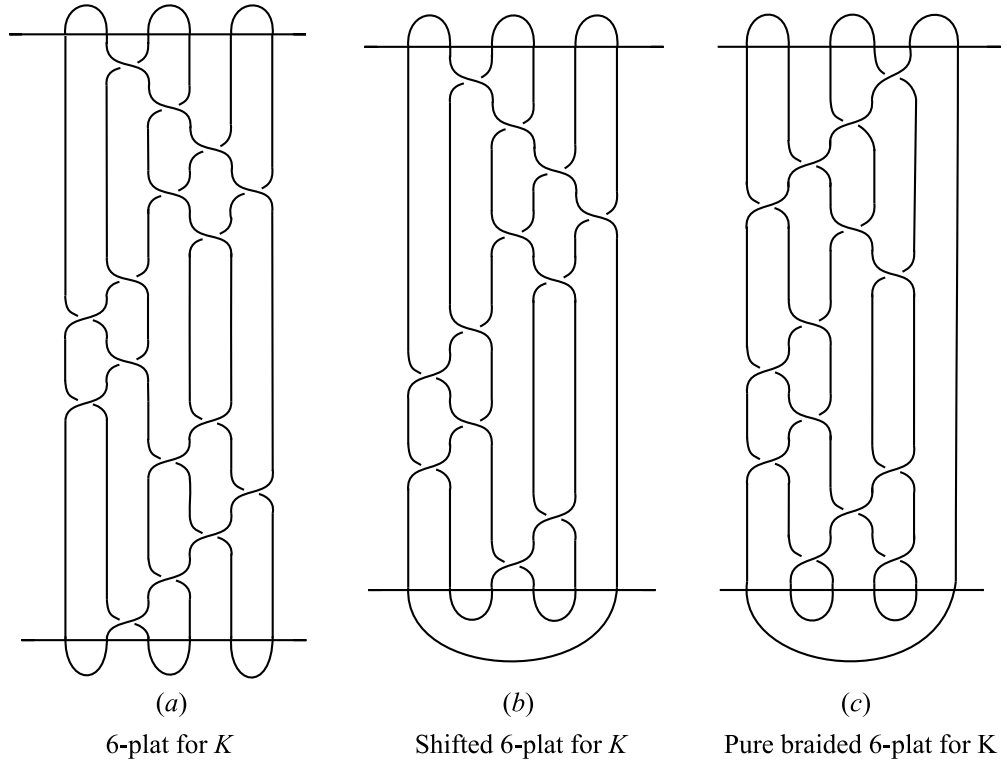

Figure 3.5: Pure braided plat presentation of the figure eight knot.

the algorithm given in Lemma 3.1.2 continue isotoping to obtain a pure braided 6-plat for the figure eight knot as in Figure 3.5(c).

Next, we decompose the pure braided 6-plat of the figure eight knot in standard generators of the pure braid group on 6-strands as in Figure 3.6(a). Now to obtain the open book decomposition which contains the figure eight knot K , we unknot K using the diagram in Figure 3.6(a). We unknot K by blowing up twists. See Figure 3.6(b). We get a link L_K of unknots linking K whose components have framing ± 1 . We continue blowing up to ensure that each component of L_K links K exactly once. See Figure 3.6(c). Notice that we add new ± 1 -framed components to the link L_K and the components of L_K link each other as the Hopf link and link the knot K only once. We continue blowing up as in Figure 3.7 to remove each linking between the components. We need to be careful with the resulting ± 1 -framed unknots linking the components of L_K . To be more precise, at each linking crossing between the components of L_K we have different choices where to blow up as explained in the proof of Theorem 3.2.1 below. We always

choose the one that guarantees that after blowing up, the resulting ± 1 -framed unknots linking the components of L_K can be isotoped to sit on the page of the open book decomposition at the end. See Figure 3.7 again.

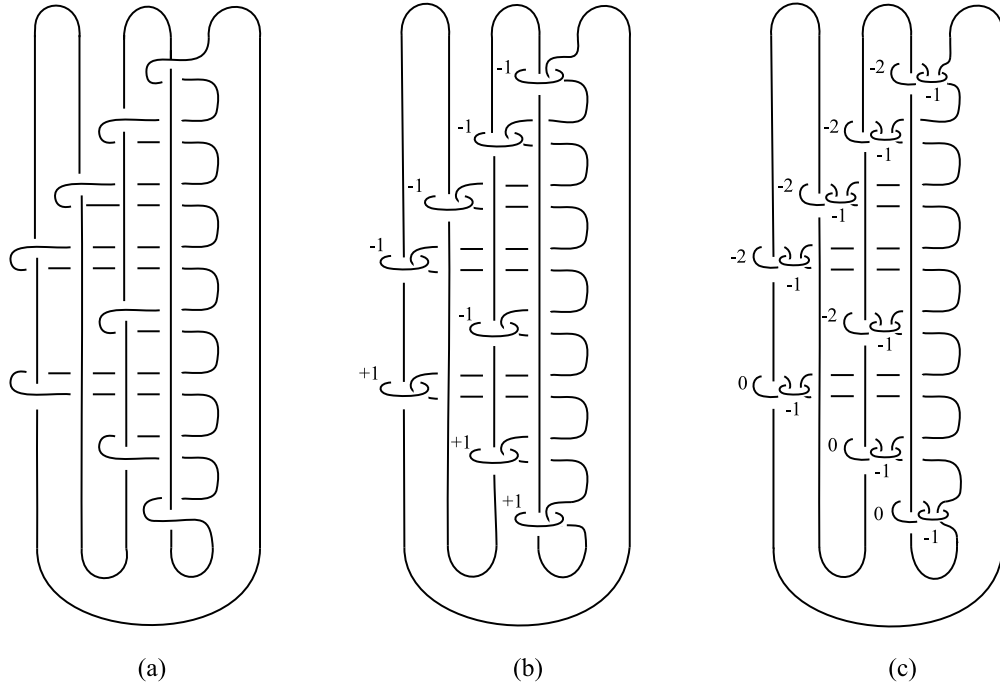

Figure 3.6: Unknotting the figure eight knot.

Finally, we blow up again as in Figure 3.8 so that each component of the link L_K has framing coefficient 0.

Now, using Lemma 2.3.11 we are in a position to see the open book decomposition explicitly. Note that we obtain a planar open book decomposition for S^3 where the figure eight knot K and each 0-framed components of L_K are the binding components of the open book decomposition and each ± 1 -framed unknots linking the components of L_K sits on the page and contributes negative/ positive Dehn twists to the monodromy of the open book decomposition respectively.

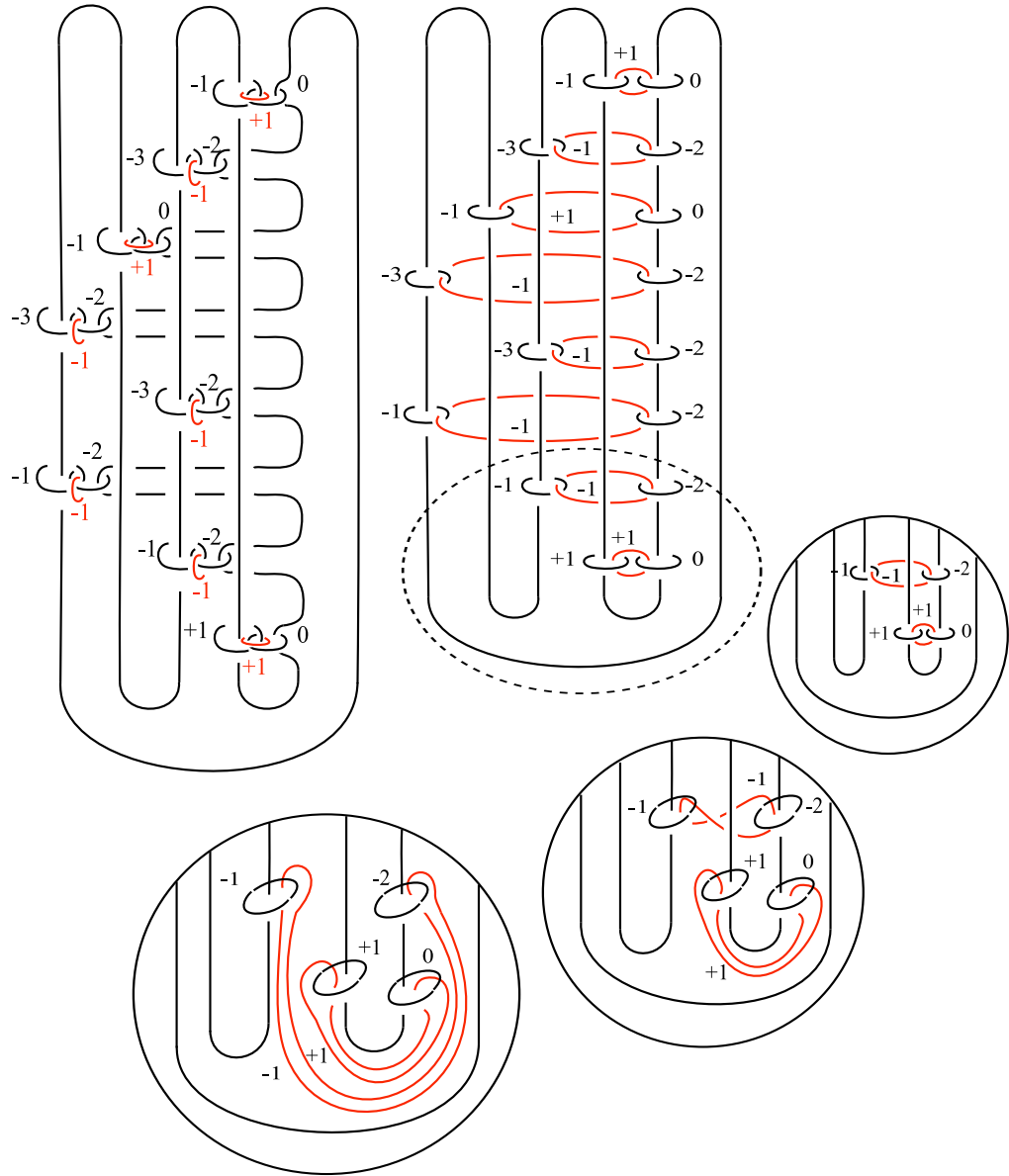

Figure 3.7: The unknotted knot K bounds a disk.

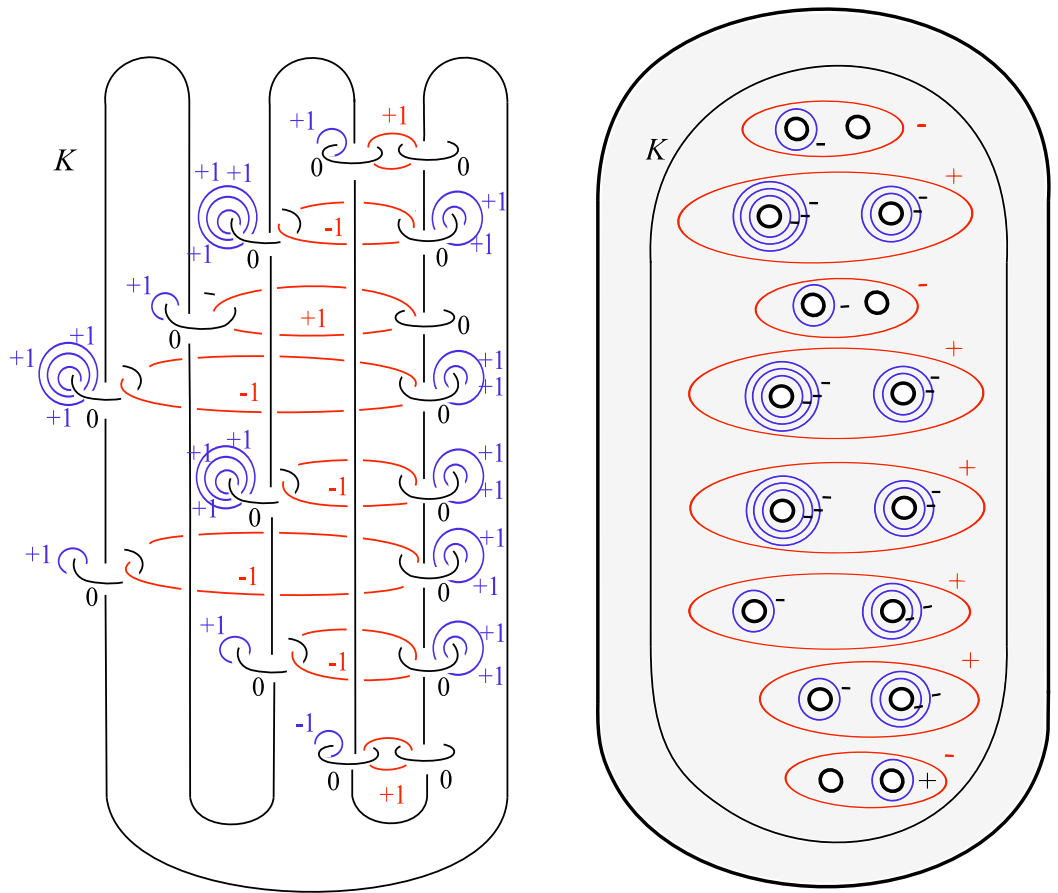

Figure 3.8: Page of a planar open book decomposition containing the figure eight knot, pages are disk with 16 punctures.

We are now ready for the proof of one of the main theorems of this chapter.

Proof of Theorem 3.2.1. Given a knot K in S^3 , we construct a planar open book of S^3 such that K is one of the binding components. We then push the knot K onto one of the pages.

First, present the knot K as a pure braided plat using the algorithm given in Lemma 3.1.2. Next, decompose the pure braided plat of K in terms of standard generators of the pure braid group. A generating set of braids A_{ij} , $1 \leq i < j \leq 2n$, for the pure braid group on $2n$ -strands is shown in Figure 3.9.

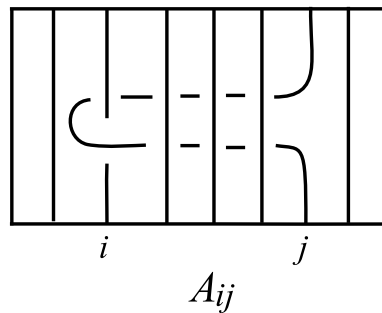

Figure 3.9: Generator A_{ij} for the pure braid group.

Note to unknot the knot K using a decomposed pure braided plat presentation of K , we only need to remove full twists. We remove twists and unknot K by blowing up. Note also that there is not a unique way to do so. The different ways of blowing up are shown in Figure 3.10.

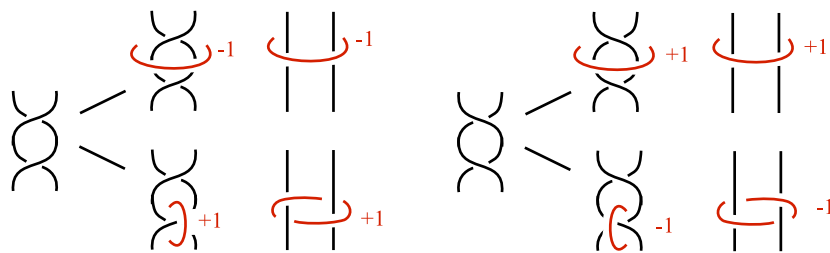

Figure 3.10: Different ways of blowing up to remove twists.

The idea of the proof is that using a pure braided plat presentation of the knot K , unknot K by blowing up several times in such a way that at the end K is the unknot which we denote by U_K

and the resulting link of unknots $L_K = L_0 \cup L_{\pm}$ coming from the blow ups linking U_K satisfy:

1. Each component of L_K links U_K only once,
2. The components of L_K are pairwise unlinked or linked as the Hopf link,
3. If the components of L_K linked as the Hopf link, then continue blowing up to remove the linking and get ± 1 -framed unknots L_{\pm} linking the components of L_K ,
4. L_{\pm} does not link U_K and each can be isotoped to sit on a disk that U_K bounds,
5. The component of L_K linking U_K only once has 0-framing, we denote such components by L_0 .

The knot U_K has a natural open book decomposition in S^3 coming from the disk it bounds. The 0-framed link L_0 of unknots puncture each disk page transversely once and we can isotope ± 1 -framed link L_{\pm} of unknots linking L_0 components onto one of the punctured disk pages. Thus, after performing surgeries U_K will be isotopic to the knot K and by Lemma 2.3.11 we will get a planar open book of S^3 where the knot U_K and the 0-framed link L_0 of unknots form the binding components and each ± 1 -framed link L_{\pm} of unknots sitting on the punctured disk page contributes to negative/ positive Dehn twist to the monodromy of the new open book decomposition respectively.

Note that it is enough to verify we can do this for the set of generators and their inverses given in Figure 3.11. All the generators fall in one of the five cases given in Figure 3.11. We explain one complicated case, (2) A_{i+1j+1} , in Figure 3.12 and we give a summary for all cases in Figure 3.13 and their inverses in Figure 3.14.

We want to remark that a pure braided plat presentation of the knot K of the type in Figure 3.1(b) allows us to isotope ± 1 -framed curves onto a page.

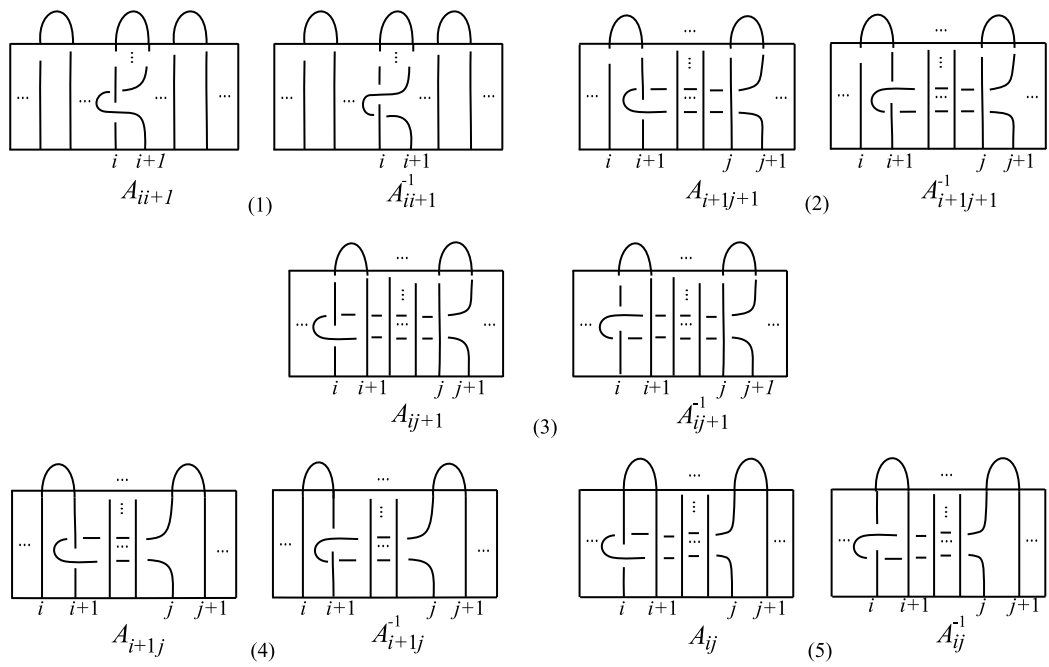

Figure 3.11: Generators: $A_{ii+1}, A_{i+1j+1}, A_{ij+1}, A_{i+1j}, A_{ij}$.

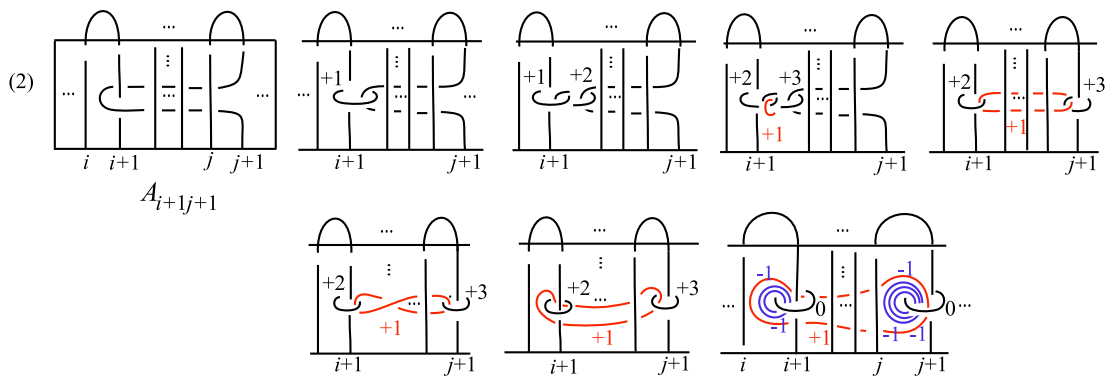

Figure 3.12: Case (2) A_{i+1j+1} .

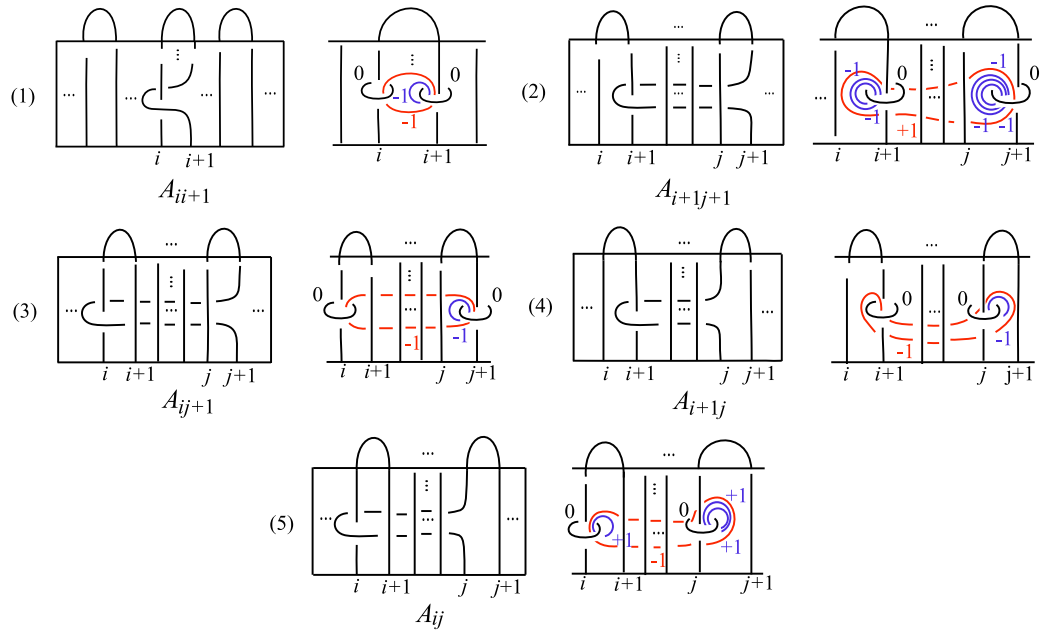

Figure 3.13: Generators: $A_{ii+1}, A_{i+1j+1}, A_{ij+1}, A_{i+1j}, A_{ij}$.

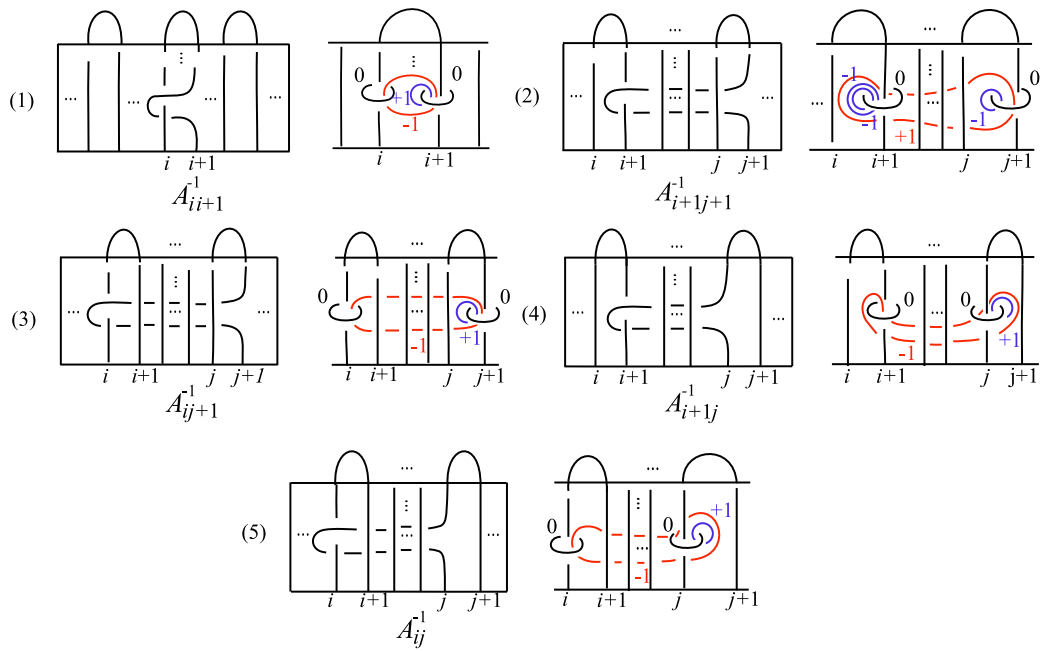

Figure 3.14: Inverses: $A_{ii+1}^{-1}, A_{i+1j+1}^{-1}, A_{ij+1}^{-1}, A_{i+1j}^{-1}, A_{ij}^{-1}$.

■

Theorem 3.2.3. *If L is a link of k components L_1, \dots, L_k in S^3 , then L is planar, that is, L sits on a page of a planar open book decomposition for S^3 .*

Proof. Here, we mimic the proof of the Theorem 3.2.1. The only modification required is at the end. Using a pure braided plat presentation of the link L , repeatedly blow up to unknot the given link L and arrange the framing of the unknots linking L only once to be 0 and remove each linking between the unknots linking L to get the middle ± 1 -framed curves. After performing the 0-surgeries, the page of the open book can be constructed by taking the connected sum of components L_1, \dots, L_k of the link L as shown in Figure 3.15.

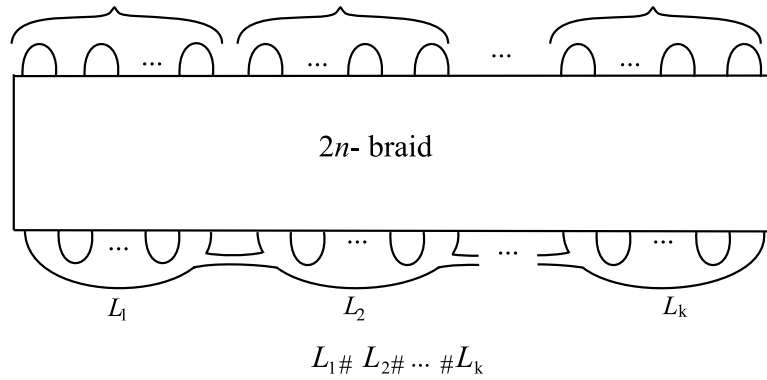

Figure 3.15: Construct the page of the open book by taking connected sum of the components L_1, \dots, L_k of the link L .

Hence, we can isotope the middle ± 1 -framed curves onto a page using the bands connecting the components. Clearly, the link L sits on a page of this planar open book. ■

Remark 3.2.4. Note that other than the unknots with 0-framing coming from resolving the generators (1) A_{ii+1} , (3) A_{ij+1} , (4) A_{i+1j} in the proof of Theorem 3.2.1, we have only -1 -framed unknots. In these cases, -1 -framed unknots contribute positive Dehn twists to the monodromy of the new open book. We want to remark that we can arrange this to be the case for all generators and their inverses. Namely, by blowing up in different ways we can make sure that other than 0-framed unknots, each case contains only -1 -framed knots. Thus, at the end we will have an open book decomposition for S^3 whose monodromy is a product of only positive Dehn twists and contains the given knot or link on its page. We discuss the cases (2) A_{i+1j+1}^{-1} and

(3) A_{ij+1}^{-1} in Figure 3.16 in detail. Other cases can be worked out similarly, we give a summary for the remaining cases in Figure 3.17.

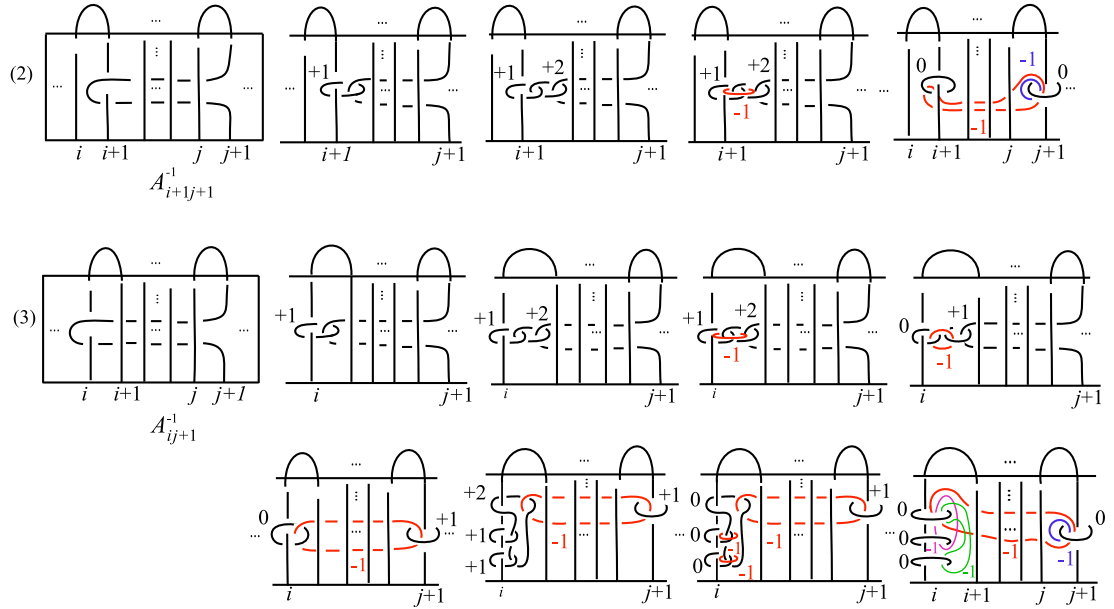

Figure 3.16: Resolving the cases (2) $A_{i+1,j+1}^{-1}$ and (3) A_{ij+1}^{-1} in such a way that the cases contribute only positive Dehn twists to monodromy.

As a consequence, we have

Theorem 3.2.5. *Any topological knot or link in S^3 sits on a planar page of an open book decomposition for S^3 whose monodromy is a product of positive Dehn twists.* ■

3.3 Knots and Links in 3-manifolds

Theorem 3.3.1. *Let L be a link of k components L_1, \dots, L_k in a closed orientable 3-manifold M . Then L is planar, that is, L sits on a page of a planar open book for M .*

Proof. It is known, see [26] and [38], that any closed orientable 3-manifold M may be obtained by ± 1 surgery on a link L_M of unknots in S^3 . Given a link L of k components L_1, \dots, L_k in a 3-manifold M , we may think of L as a link in S^3 which is disjoint from the surgery link L_M . Now using the algorithm described in Theorem 3.2.3 we can find a planar open book decomposition

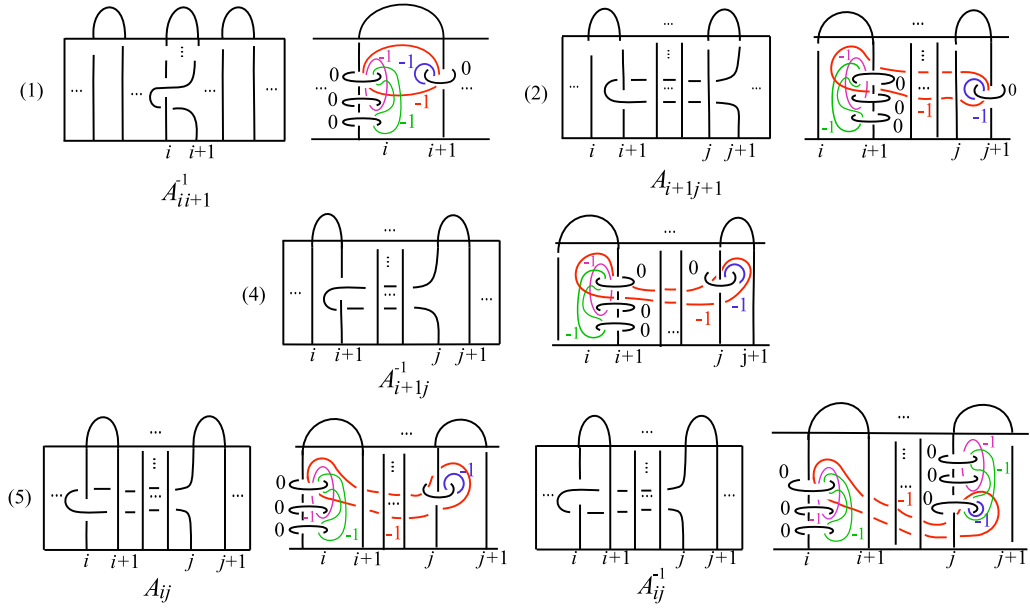

Figure 3.17: Other than 0-framed knots each remaining case contains only -1 -framed knots.

for S^3 such that the link $L \sqcup L_M$ sits on its page. Also, using a similar idea in Lemma 2.3.10 we can arrange framing of each component of L_M sitting on a page to be ± 1 with respect to the page framing by first stabilizing the open book and then pushing the knot L over the 1-handle that we use to stabilize the open book. Then away from the link L , we can perform ± 1 surgeries on L_M which yield a planar open book for the 3-manifold M containing the link L on its page. Moreover, this new open book has a monodromy which is the old monodromy composed with negative/ positive Dehn twists along each ± 1 -framed component of the link L_M . ■

Corollary 3.3.2. Any knot K in a 3-manifold M is planar, that is, K sits on a page of a planar open book for M .

Remark 3.3.3. It is well known that any closed, orientable 3-manifold M has an open book decomposition, [2], in particular has a planar open book decomposition, [33]. Different ways of constructing open book decompositions for 3-manifolds are known for a long time. In fact, by Theorem 3.3.1 a planar open book for a link L in a closed orientable 3-manifold M gives a planar open book decomposition for M . Here we want to remark that using the idea in the proof of Theorem 3.2.1 an alternative way of constructing explicit planar open books for any given 3-manifold M can be given. Namely, we can determine the monodromy of the planar

open book for M .

Theorem 3.3.4. *Every closed orientable 3-manifold has a planar open book decomposition.*

Proof. Assume that given 3-manifold M is obtained by ± 1 -surgery on a link L_M of n unknots. We can present the link L_M as the closure of a n -braid as in Figure 3.18. Notice that since we have a link of n unknots, n -braid in Figure 3.18 is a pure braid. Now, decompose the pure braid in terms of standard generators of the pure braid group on n -strands.

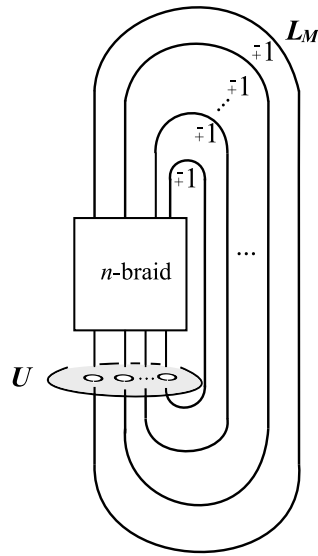

Figure 3.18: ± 1 -surgery on a link L_M of n unknots giving the 3-manifold M .

Consider the unknot U in Figure 3.18. We will construct a planar open book for M using the planar open book $(U, D, \varphi = Id)$ of S^3 where the binding is the unknot U , pages are disk D and the monodromy φ is the Id . We remove each linking between the components of the surgery link L_M by blowing up so that the resulting ± 1 -framed unknots can be isotoped to sit the disk that U bounds. Note each component of the link L_M punctures transversely once the disk that U bounds. We continue blowing up to arrange the framing coefficient of each component of L_M to be zero. Then by Lemma 2.3.11, we will have a planar open book for M where the pages are disk with n -punctures and the monodromy is a product of negative/ positive Dehn twists along the ± 1 - framed surgery curves on the punctured disk that U bounds. ■

Example 3.3.5. Consider the Poincaré homology sphere $\Sigma(2, 3, 5)$ which can be given by a

surgery on the Borromean link as in Figure 3.19.

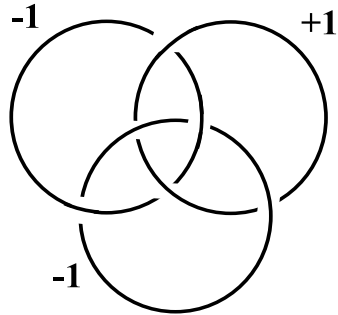

Figure 3.19: Surgery on a Borromean link giving the Poincaré homology sphere.

We construct a planar open book for $\Sigma(2, 3, 5)$ using the given surgery diagram as follows: First we present the Borromean link as a pure 3-braid and we decompose the pure braid in terms of standard generators of the pure braid group on 3-strands. Next, we remove each linking between the components of the Borromean link by blowing up and we continue blowing up to arrange the framing of each component of the Borromean link to be 0. See Figure 3.20.

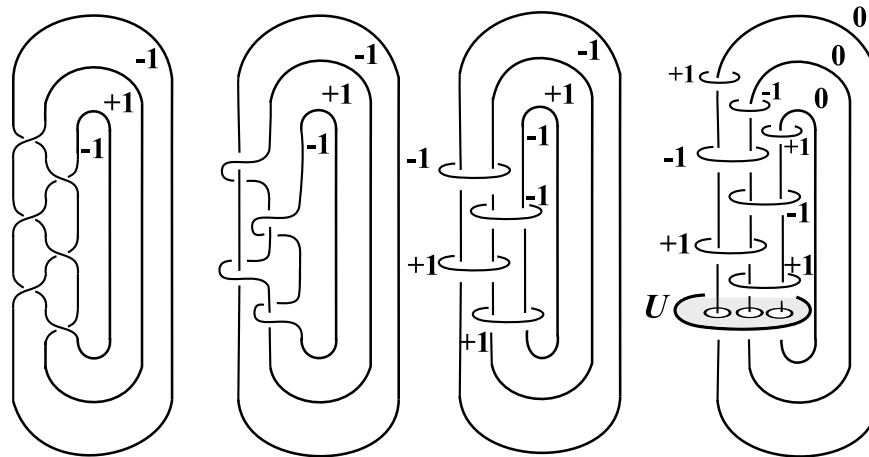

Figure 3.20: Pure braid representation of Borromean link and a way of resolving the twists.

Now, using the unknot U given in Figure 3.20 and using its natural fibration in S^3 , we construct a planar open book decomposition for $\Sigma(2, 3, 5)$. We slide the surgery curves on to the disk that

U bounds and we perform the surgeries on the page. By Lemma 2.3.11, after performing 0-framed surgeries, each component of the Borremean link becomes a binding component δ_1, δ_2 and δ_3 . Note that we set the notation for binding components from inner component to outer component. By Lemma 2.3.11 again, we know that each ± 1 -framed surgery curve contribute negative/ positive Dehn twist to the monodromy of the starting open book which in this case is the identity. Hence, the monodromy of the open book is given by $\varphi = t_\beta^{-1} t_\alpha^{-1} t_\beta t_\alpha t_{\delta_1}^{-1} t_{\delta_2} t_{\delta_3}^{-1}$.

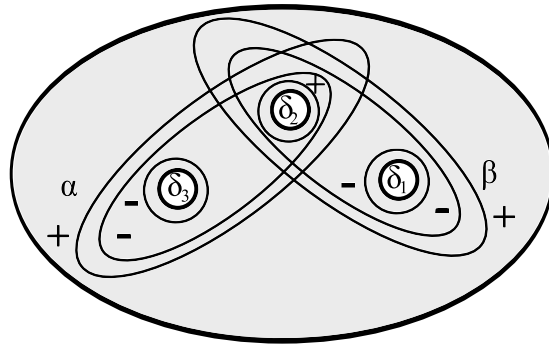

Figure 3.21: A planar open book for the Poincaré homology sphere, the monodromy φ is $\varphi = t_\beta^{-1} t_\alpha^{-1} t_\beta t_\alpha t_{\delta_1}^{-1} t_{\delta_2} t_{\delta_3}^{-1}$.

CHAPTER 4

LEGENDRIAN KNOTS AND OPEN BOOK DECOMPOSITIONS

In this chapter, we study the contact geometric properties of knots sitting on the pages of open book decompositions. In Section 4.1, we define the support genus of Legendrian knots. In the following sections, first we study the support genus of Legendrian knots in overtwisted contact 3-manifolds and then in tight contact 3-manifolds. Finally, we study the support genus of Legendrian knots in arbitrary contact 3-manifolds. We list several observations related to support genus of knots.

4.1 Support Genus of Legendrian Knots

Definition 4.1.1. The *support genus* $sg(L)$ of a Legendrian knot L in a contact 3-manifold (M, ξ) is the minimal genus of a page of an open book decomposition of M supporting ξ such that L sits on a page of the open book and the framings given by ξ and the page agree.

Given a Legendrian knot L in a contact 3-manifold (M, ξ) , one can always find an open book decomposition compatible with ξ containing L on a page such that the contact framing of L is equal to the framing given by the page. Such an open book decomposition for (M, ξ) can be constructed by an application of Giroux's algorithm, using a contact cell decomposition of (M, ξ) and including the given Legendrian knot L in the 1-skeleton of the contact cell decomposition, [20]. For Legendrian knots in (S^3, ξ_{std}) an alternative algorithm that uses the front projection of Legendrian knots can be found in [1], cf. also [3]. Thus the support genus $sg(L)$ of a Legendrian knot L is well defined.

We want to remark that definition of support genus for Legendrian knots can be extended to Legendrian links.

Example 4.1.2. Consider the Legendrian unknot L in (S^3, ξ_{std}) as shown in Figure 4.1. The Legendrian unknot L sits on the page of an open book decomposition $(H^+, A, \varphi = t_\alpha)$ of (S^3, ξ_{std}) . Thus, the support genus of L is zero.

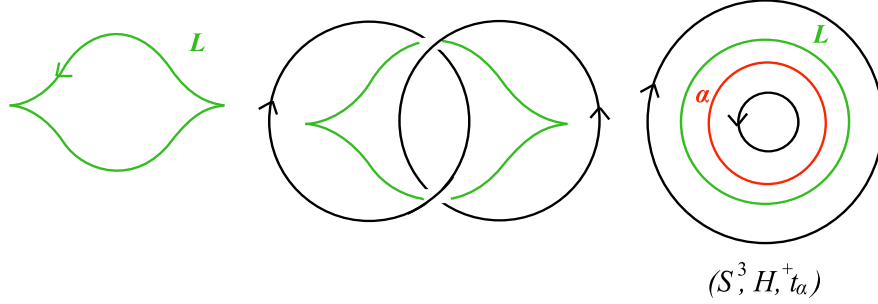

Figure 4.1: Legendrian unknot L , $tb(L) = -1$, $rot(L) = 0$, $sg(L) = 0$.

4.2 Legendrian Knots in overtwisted contact structures

Recall that there are two types of Legendrian knots in overtwisted contact structures: loose Legendrian knots and non-loose Legendrian knots.

4.2.1 Loose Legendrian Knots

Theorem 4.2.1. *If L is a null-homologous Legendrian loose knot in an overtwisted contact 3-manifold (M, ξ_{ot}) , then $sg(L) = 0$.*

Proof. It is known that if two null-homologous Legendrian loose knots L_1 and L_2 in a knot type K have the same Thurston-Bennequin invariant and the same rotation number, then there is a contactomorphism ψ of (M, ξ_{ot}) such that $\psi(L_1) = L_2$, [17]. Here, we show that we can realize any pair of integers (m, n) with $m \pm n$ odd as $(tb(L), r(L))$ for a null-homologous loose knot L in a knot type K that sits on a planar open book (S, φ) supporting (M, ξ_{ot}) . By Theorem 3.3.1, we know there is a planar open book decomposition, say (S_K, φ_K) , for M such that K lies on a page of the open book. The planar open book (S_K, φ_K) is compatible with some contact structure ξ' on M . If necessary we can negatively stabilize the open book in such a way that the resulting open book is still planar and it is overtwisted. Furthermore, following [11] we can assume that

ξ' is the same as the overtwisted contact structure ξ_{ot} . Briefly, by performing necessary Lutz twists and taking plumbing of (S_K, φ_K) with an appropriate overtwisted open book for S^3 , we can arrange the 2-dimensional invariants d_2 and the 3-dimensional invariants d_3 of ξ' and ξ_{ot} to be the same. Thus, the two contact structures will be homotopic, [21]. Then, by Eliashberg [9] two overtwisted contact structures will be isotopic. Note that we can do this keeping the open book planar and keeping the given knot K on the page. For the details of how to arrange invariants of overtwisted contact structures, see the proof of Theorem 3.5 in [11].

Now, we can assume that the planar open book (S_K, φ_K) containing the knot K on its page is compatible with the overtwisted contact structure ξ_{ot} on M . If necessary by stabilizing the open book positively and pushing the knot K over the 1-handle, we may assume K is non-separating and we may Legendrian realize the knot K on the page, say it has a Thurston-Bennequin invariant t' and a rotation number r' . To realize any pair $(tb(L), r(L))$ for any Legendrian representative of the knot K from the pair (t', r') , first realize the appropriate Thurston-Bennequin invariant $tb(L)$. If $t' > tb(L)$, then to decrease the Thurston-Bennequin invariant stabilize the knot positively or negatively on the page by using Lemma 2.3.10(1). Modify the open book as in Figure 2.6(a) or (b), both will decrease $tb(L)$. Note, this modification alters neither the contact structure nor the genus of the open book. Now, if $t' < tb(L)$, then to increase the Thurston-Bennequin invariant we need to destabilize the knot positively or negatively on the page by using Lemma 2.3.10(2). Note, this modification alters the contact structure. However, as before, away from the knot by taking plumbing of this new open book of M with an appropriate overtwisted open book of S^3 , we can make sure that the resulting overtwisted contact structure is still isotopic to ξ_{ot} .

Now, once we realize the pair $(tb(L), r'')$, to complete the proof we only need to realize any possible rotation number $rot(L)$ from r'' . To increase or decrease the rotation number, we will use Lemma 2.3.10 again and stabilize the knot positively or negatively on the page. Recall that a positive and a negative stabilization of a knot increase and decrease the rotation number by 1, respectively and also recall that both stabilizations decrease the Thurston-Bennequin invariant $tb(L)$ by 1. Thus, every time we increase or decrease r'' , we need to make sure that $tb(L)$ stays the same. Clearly, this is possible since to increase the rotation number if we first positively stabilize the knot on the page as in Figure 2.6(a) and then negatively destabilize the knot on the page as in Figure 2.6(d), the rotation number will increase by 2 and $tb(L)$ stays the same. Note after negatively stabilizing the open book, we again perform a plumbing operation to keep the contact structure same as ξ_{ot} . Similarly, to decrease the rotation number, we first

modify the open book as in Figure 2.6(b) and then as in Figure 2.6(c), this time the rotation number will decrease by 2 and $tb(L)$ stays the same. Since $tb(L) \pm rot(L)$ is odd, we can realize any pair $(tb(L), rot(L))$. Thus, for any null-homologous loose Legendrian representative of the knot K we can find a planar open book decomposition supporting ξ_{or} such that the Legendrian representative sits on the page. ■

4.2.2 Non-loose Legendrian Knots

There are examples of support genus zero non-loose knots in overtwisted contact structures.

Example 4.2.2. The contact 3-manifold given by the surgery diagram in Figure 4.2 is an overtwisted (S^3, ξ_n) with $d_3(\xi_n) = 1 - np(p - 1)$. The Legendrian knot L_n in (S^3, ξ_n) is non-loose with support genus zero and topologically a $(p, pn + 1)$ positive torus knot. When $p = 2$, Legendrian non-loose knots of knot type $(2, 2n + 1)$ positive torus knots first appeared in [28].

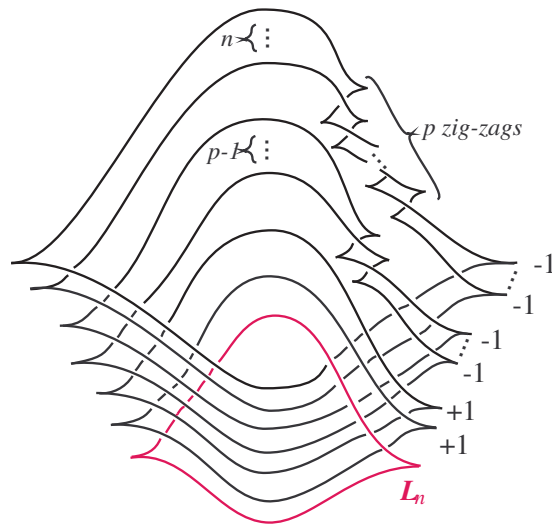

Figure 4.2: Legendrian Torus knots.

Let X denote the 4-manifold obtained by viewing the integral surgeries as 4-dimensional 2-handle attachments to B^4 . With the help of X , we can compute the 3-dimensional invariant $d_3(\xi_n)$ of the contact structure ξ_n . From Figure 4.3, the signature of X is $\sigma(X) = -n - p + 1$ and the Euler characteristic of X is $\chi(X) = n + p + 1$. Also, using a second cohomology class

$c \in H^2(X, \mathbb{Z})$ defined by the rotation number, we compute $c^2 = -n(2p - 1)^2 - (p - 1)$. From the formula:

$$d_3(\xi) = \frac{1}{4}(c^2 - 3(\sigma(X)) - 2\chi(X)) + q,$$

where q denotes the number of $+1$ -contact surgeries, we compute the 3-dimensional invariant of ξ_n as $d_3(\xi_n) = 1 - np(p - 1)$. Note that ξ_n is overtwisted since $d_3(\xi_n) < 0$. Note also that L_n is non-loose since Legendrian surgery along L_n cancels one of the $+1$ -surgeries in Figure 4.2 and results in a tight contact structure. By a similar argument used in [35], the surgery link together with the Legendrian knot L_n given in Figure 4.2 can be put on a page of a planar open book of (S^3, ξ_{st}) . After performing surgeries, we will get (S^3, ξ_n) compatible with a planar open book containing the Legendrian knot L_n on its page. Therefore, $sg(L_n) = 0$.

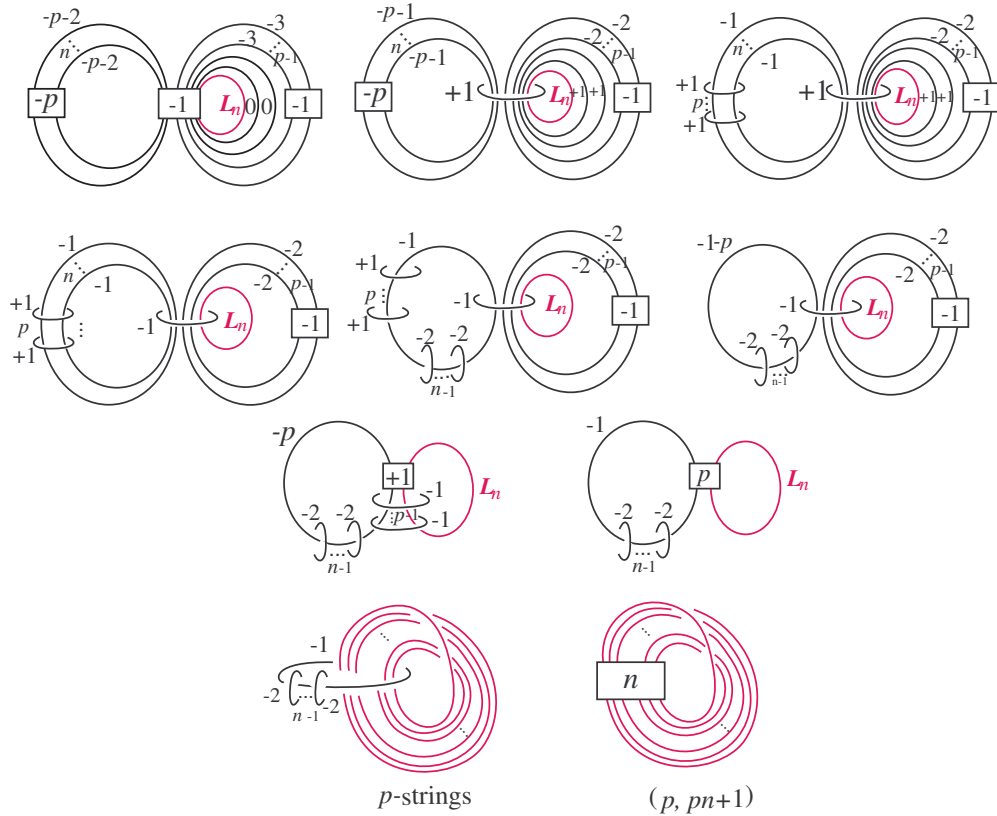

Figure 4.3: $(p, pn + 1)$ Torus knots.

There are examples of support genus non-zero non-loose knots in overtwisted contact structures.

Example 4.2.3. Consider a Legendrian knot L with a Thurston-Bennequin invariant $tb(L) > 0$ in (S^3, ξ_{std}) . Let (M, ξ) denote the contact 3-manifold results from a +1-contact surgery along a positive stabilization $S_+(L)$ of the Legendrian knot L . (M, ξ) is overtwisted by [30], also by [27]. Since $tb(S_+(L)) \geq 0$ according to Remark 4.3.2 below, $sg(S_+(L)) > 0$. Note the image $S_+(L)'$ of $S_+(L)$ in the surgered overtwisted contact manifold (M, ξ) is a non-loose Legendrian knot with a non-zero support genus. The Legendrian knot $S_+(L)'$ is non-loose since the complement of $S_+(L)'$ in (M, ξ) is contactomorphic to the complement of $S_+(L)$ in (S^3, ξ_{std}) and $sg(S_+(L)') > 0$, otherwise this would contradict to the fact that $sg(S_+(L)) > 0$.

Remark 4.2.4. As we discussed in Example 4.2.3 above, in overtwisted contact structures there are examples of non-loose knots having support genus non-zero. Let L be a null-homologous, support genus non-zero, non-loose Legendrian knot of knot type K in an overtwisted contact manifold (M, ξ_{ot}) . We can find a loose knot \tilde{L} of knot type K in (M, ξ_{ot}) such that \tilde{L} has the same classical invariants as L . Moreover, by Theorem 4.2.1 it follows that $sg(\tilde{L}) = 0$. Thus, we have examples of knots having the same classical invariants but different support genus in overtwisted contact structures.

4.3 Legendrian Knots in tight contact structures

In Chapter 3, we showed that any topological knot or link in S^3 sits on a planar page of an open book decomposition of S^3 . Moreover, we showed that we can arrange the monodromy of the open book decomposition to be a product of positive Dehn twists only. In [20], Giroux showed that a contact 3-manifold is Stein fillable if and only if there is a compatible open book decomposition for the contact manifold whose monodromy is a product of positive Dehn-twists. Since there is a unique tight contact structure on S^3 , the planar open book we constructed for a given knot or link in S^3 will be compatible with (S^3, ξ_{std}) . For a given knot K in S^3 after putting the knot K on a page of a planar open book with positive monodromy, we may Legendrian realize the knot K on the page. If necessary first we may arrange K to be non-separating on the page by stabilizing the open book positively and pushing the knot K over the 1-handle and then we may Legendrian realize the knot K on the page. As a consequence, we have

Theorem 4.3.1. *Given a knot type K in (S^3, ξ_{std}) , there is a Legendrian representative L of K such that $sg(L) = 0$.*

It is easy to find examples of support genus non-zero Legendrian knots in weakly fillable tight contact structures.

Lemma 4.3.2. *If L is a Legendrian knot in a weakly fillable tight contact structure with a Thurston-Bennequin invariant $tb(L) > 0$, then $sg(L) > 0$. In particular, any Legendrian knot L in (S^3, ξ_{std}) with Thurston-Bennequin invariant $tb(L) \geq 0$ has $sg(L) > 0$.*

Proof. In [11], Etnyre gives constraints on contact structures having support genus zero. In particular, according to [11] a contact 3-manifold (M, ξ) obtained by a Legendrian surgery along a Legendrian knot L in a weakly fillable contact structure having Thurston-Bennequin invariant $tb(L) > 0$ has $sg(\xi) > 0$. If a Legendrian knot with $tb(L) > 0$ had support genus $sg(L) = 0$, then performing a Legendrian surgery along L sitting on a planar page would yield a contact 3-manifold (M, ξ) with support genus $sg(\xi) = 0$, which is not the case. Therefore, such a Legendrian knot has $sg(L) > 0$. The Legendrian knots with $tb(L) = 0$ has $sg(L) > 0$ follows from [32]. ■

4.4 Legendrian Knots in contact structures

As explained in Lemma 2.3.10(1), if a Legendrian knot L sits on a page of an open book decomposition, then positive or negative stabilization of L can be seen on the page of the open book as in Figure 2.6(a) and (b). Note that we add 1-handles in such a way that the resulting open book still has the same genus. As a result, we have

Theorem 4.4.1. *If a Legendrian knot L has support genus $sg(L) = n$, then the stabilizations $S_+^{n_1} S_-^{n_2}(L)$ of L have the support genus $sg(S_+^{n_1} S_-^{n_2}(L)) \leq n$.*

By the above Theorem 4.4.1, given a knot type K , if all Legendrian knots realizing K without maximal Thurston-Bennequin invariant destabilize and the Legendrian knots with maximal Thurston-Bennequin invariant has support genus zero, then all Legendrian knots of the knot type K has support genus zero. For example, all Legendrian unknots in (S^3, ξ_{std}) are planar.

Remark 4.4.2. Note that the support genus of a Legendrian knot gives an upper bound on the support genus of a contact structure, that is, $sg(L) \geq sg(\xi)$. So, if there is a Legendrian knot L in a contact 3-manifold (M, ξ) having support genus zero, then $sg(\xi) = 0$.

Recall that for a non-zero rational number $r \in \mathbb{Q}$, a contact r -surgery on a Legendrian knot L in a contact 3-manifold (M, ξ) is a topological r -surgery with respect to the contact framing.

The resulting manifold is a new contact 3-manifold (M', ξ') where the contact structure ξ' is constructed by extending ξ from the complement of a standard contact neighborhood of L to a tight contact structure on the glued solid torus, [5]. Such an extension always exists and it is unique when $r = \frac{1}{k}$, $k \in \mathbb{N}$, [23].

Theorem 4.4.3. *Let L be a Legendrian knot in a contact 3-manifold (M, ξ) such that $sg(L) = 0$. Then, the contact 3-manifold (M', ξ') obtained from M by a contact r -surgery along L has $sg(\xi') = 0$.*

We want to remark that rational contact surgeries on a Legendrian link in (S^3, ξ_{std}) on pages of open book decompositions first discussed in [29].

Proof. Case 1. Contact r -surgery with $r < 0$: Consider a continued fraction expansion of $r - 1$

$$[r_1, r_2, \dots, r_n] = r_1 - \frac{1}{r_2 - \frac{1}{\dots - \frac{1}{r_n}}}$$

with integers $r_i \leq -2$, $i = 1, \dots, n$. Let L_1 be the $|r_1 + 1|$ times stabilization of the front projection of the Legendrian knot L and let L_i be the Legendrian push off of L_{i-1} with additional $|r_i + 2|$ stabilizations, $i = 2, \dots, n$. Then following [5], we can replace contact r -surgery along L by a sequence of contact -1 -surgeries along L_1, \dots, L_n . Since the support genus $sg(L) = 0$, by Lemma 2.3.10(1) and by keeping the page of the open book planar we can realize each L_i on a planar open book containing L on its page. Again by using Lemma 2.3.10(1) we can arrange framing of each L_i sitting on a planar page to be -1 with respect to the page framing. After performing contact surgeries, we will obtain a support genus zero contact 3-manifold.

Case 2. Contact r -surgery with $r = \frac{p}{q} > 0$, $(p, q) = 1$: According to [5], a contact $r = \frac{p}{q}$ -surgery along L corresponds to k contact $+1$ -surgeries along k Legendrian push offs of L followed by a contact $r' = \frac{p}{q - kp}$ -surgery along a Legendrian push off of L for any integer $k \in \mathbb{N}$ such that $q - kp < 0$. By starting with a planar open book containing the Legendrian knot L on its page, we can easily see k Legendrian push offs of L on the page and by using Lemma 2.3.10(1) we can arrange the framings of each push off of L sitting on a planar page to be $+1$ with respect to the page framing. Hence to complete the proof we only need to show that we can perform $r' < 0$ surgery on a Legendrian push off of L on the page also, but this can be easily arranged as we did in Case 1. ■

REFERENCES

- [1] S. Akbulut, B. Ozbagci, *Lefschetz fibrations on compact Stein surfaces*, Geom. Top. **5**, (2001), 319–334.
- [2] J. W. Alexander, *A lemma on systems of knotted curves*, Proc. Nat. Acad. Sci., USA **9**, (1923), 93–95.
- [3] F. Arikian, *On the support genus of a contact structure*, Journal of GGT., **1**(2007), 92–115.
- [4] J. Birman, *Braids, links and mapping class groups*, Anals.of Math. Studies, Princeton University Press, **82**, (1975).
- [5] F. Ding, H. Geiges, *A Legendrian surgery presentation of contact 3-manifolds*, Math. Proc. Cambridge Philos. Soc. **136**, (2004), 41–74.
- [6] F. Ding, H. Geiges, A. Stipsicz, *Surgery diagrams for contact 3-manifolds*, Math. Proc. Cambridge Philos. Soc. **136**, (2004), 41–74.
- [7] K. Dymara *Legendrian knots in overtwisted contact structures*, arxiv:math/0410122.
- [8] Y. Eliashberg, *Filling by holomorphic discs and its applications*, Geometry of low-dimensional manifolds, **2** (Durham, 1989), 45–67, London Math. Soc. Lecture Note Ser., **151**, Cambridge Univ. Press, Cambridge, (1990).
- [9] Y. Eliashberg, *Classification of overtwisted contact structures on 3-manifolds*, Invent. Math. **98**, (1989), 623–637.
- [10] J. B. Etnyre, *Introductory lectures on contact geometry*, Topology and Geometry of Manifolds, Athens (2001), 81–107, Proc. Sympos. Pure Math., **71**, American Mathematical Society (2003).
- [11] J. B. Etnyre, *Planar open book decompositions and contact structures*, IMRN. **79**, (2004), 4255–4267.
- [12] J. B. Etnyre, *Legendrian and transverse knots*, Handbook of Knot Theory, Elsevier (2005), 105–185.
- [13] J. B. Etnyre, *Lectures on open book decompositions and contact structures*, Floer Homology, Gauge Theory and Low dimensional Topology, Caly Math. Proc. **5**, American Mathematical Society (2006), 103–141.
- [14] J. B. Etnyre, K. Honda *On the nonexistence of tight contact structures*, Ann. of Math. **153**, (2001) 749–766.

- [15] J. B. Etnyre, K. Honda *Knots and contact geometry I torus knots and the figure eight knot*, J. Symp. Geom. **1**,(2001) 63–120.
- [16] J. B. Etnyre, B. Ozbagci, *Invariants of contact structures from open books*, Trans. Amer. Math. Soc **260**, (2008), 3133–3151.
- [17] J. B. Etnyre, *A note on knots in overtwisted contact structures*, in preparation.
- [18] D. Gabai, *Murasugi sum is a natural geometric operation*, Low dimensional Topology (San Francisco, CA 1981) 131–143, Contemp. Math. **20**, Amer. Math. Soc. Providence, RI, (1983).
- [19] H. Geiges, *An introduction to Contact Topology*, Cambridge Studies in Advanced Mathematics, **109**. Cambridge University Press, Cambridge, (2008).
- [20] E. Giroux, *Géométrie de contact: de la dimension trois vers les dimensions supérieures*, Proc. of the Int. Cong. of Math. Vol. **II** (Beijing, 2002), Higher Ed. Press, 405–414.
- [21] R. Gompf, *Handbody construction of Stein surfaces*, Annals. of Math. **148**, (1998), 619–693.
- [22] M. Gromov, *Pseudoholomorphic curves in symplectic manifolds*, Invent. Math. **82**, (1985), no. 2, 307–347.
- [23] K. Honda, *On the classification of tight contact structures I*, Geo. Topol. **4**, (2000), 309–368.
- [24] Y. Kanda, *The classification of tight contact structures on the 3-torus*, Comm. in Anal. and Geom. **5**, (1997), 413–438.
- [25] Y. Kanda, *On the Thurston-Bennequin invariant of Legendrian knots and nonexactness of Bennequin’s inequality*, Invent. Math. **133**, (1998), no. 2, 227–242
- [26] W. B. Lickorish, *A presentation of orientable combinatorial 3-manifolds*, Ann. of Math. **76**, **2**, (1962), 531–540.
- [27] P. Lisca, A. I. Stipsicz, *Notes on the contact Ozsvath-Szabo invariants*, Pacific J. Math. **228**, **2**, (2006) 277–295.
- [28] P. Lisca, P. Ozsváth, A. I. Stipsicz, Z. Szabó *Heegaard Floer invariants of Legendrian Knots in contact 3-manifolds*, preprint.
- [29] B. Ozbagci, *An open book decomposition compatible with rational contact surgery*, Proceedings of Gökova Geometry-Topology Conference (2005), 175–186.
- [30] B. Ozbagci, *A note on contact surgery diagrams*, Internat. Journal of Math., **16** **2** (2005) 87–99.
- [31] B. Ozbagci, A. I. Stipsicz, *Surgery on contact 3-manifolds and Stein surfaces*, Bolyai Society Mathematical Studies, **13**. Springer-Verlag, Berlin; János Bolyai Mathematical Society, Budapest, (2004).

- [32] P. Ozsváth, A. I. Stipsicz, Z. Szabó, *Planar open books and Floer homology*, Int. Math. Res. Not., **54**, (2005), 3385–3401.
- [33] D. Rolfsen, *Knots and Links*, Mathematical Lecture Series **7**, Publish or Perish Inc., (1976).
- [34] L. Rudolph, *An obstruction to sliceness via contact geometry and "classical" gauge theory*, Invent. Math. **119**, (1995), 155–163.
- [35] S. Schönenberger, *Planar open books and symplectic fillings*, Ph.D thesis, University of Pennsylvania, (2005).
- [36] W. P. Thurston, H. E. Winkelnkemper, *On the existence of contact forms*, Proc. Amer. Math. Soc. **52**, (1975), 345–347.
- [37] I. Torisu, *Convex contact structures and fibered links in 3-manifolds*, Internat. Math., Res. Notices **9**, (2000), 441–454.
- [38] A. H. Wallace, *Modifications and cobounding manifolds*, Canad. J. Math., Vol. **12**, (1960), 503–528.

VITA

PERSONAL INFORMATION

Surname, Name: Çelik Onaran, Sinem

Nationality: Turkish (TC)

Phone: +90 505 703 8386

email: sinemocelik@gmail.com

EDUCATION

Ph.D. in Mathematics, Middle East Technical University, Spring 2009

Advisor: Prof. Dr. Mustafa Korkmaz

Co-advisor: Prof. Dr. John B. Etnyre

Thesis Title: Legendrian Knots and Open book decompositions

M.S. in Mathematics, Middle East Technical University, Spring 2006

Thesis Title: Contact Surgery on Contact 3-manifolds

B.S. in Mathematics, Middle East Technical University, June 2003

B.S in Industrial Design, Middle East Technical University, June 2003

RESEARCH INTERESTS

Low-Dimensional Topology, Contact Geometry, Knot Theory, Lefschetz Fibrations on 4-Manifolds

AWARDS AND SCHOLARSHIPS

Partial Support to visit the Georgia Institute of Technology provided by NSF grant DMS-0804820, September 2008-May 2009

Ph.D. Research Award by The Scientific and Technological Research Council of Turkey (TUBITAK), August 2007-May 2008

Ph.D. Scholarship by The Scientific and Technological Research Council of Turkey (TUBITAK),
March 2006-August 2008

PUBLICATIONS

Legendrian Knots in Lens Spaces, preprint

Invariants of Legendrian Knots from Open Book Decompositions, preprint

Positive Dehn Twist Expressions for Lefschetz Fibrations on $E(n)_K$ and Examples of Exotic Small 4-Manifolds, joint with A. Akhmedov, B. D. Park, preprint

On Sections of Genus two Lefschetz Fibrations, preprint

TEACHING EXPERIENCE

Teaching Assistant Calculus I-II, Department of Mathematics,
Middle East Technical University, Fall 2006, Spring 2007

Teaching Assistant Calculus I-II, Department of Secondary Science and Mathematics Education,
Baskent University, Fall 2005, Spring 2006

Teaching Assistant Differential Geometry, Department of Mathematics,
Middle East Technical University, Spring 2004

Teaching Assistant Basic Algebraic Structures, Department of Mathematics,
Middle East Technical University, Fall 2004